

Drainage & Profile Systems





PH DESIGN has been established in 2006. Produced stainless steel decorative building products. It has been investing with emphasis on R&D studies. Ph Design meet the demands with the goal of leadership in quality, service and innovations, with a rich variety of products and network of dealers in foreign and domestic markets. Meeting the demands with the goal of leadership in sector quality, service and innovations, with a rich variety products and network of dealers in foreign and domestic markets by the firm.

With high –value product structure and using the latest technology, design of molds gives form to the stainless steel.

Our company has been closely monitoring today trend and technology with taking its signature to each design and each year go on its way to becoming strong brand.

Changes Bathrooms and kitchens chemistry with modern, minimalist and rich design.

2006 yılında kurulan PH DİZAYN paslanmaz çelik dekoratif duvar kaplama ürünleri üretiminde Ar-Ge çalışmalarına önem vererek müşteri ve pazar taleplerini gözeterek yatırımlarını gerçekleştirmektedir.

Kalite, hizmet ve yenilikçilikte sektör liderliği hedefi ile çalışmalarını sürdüren Ph Dizayn gerek yurtdışı pazarı gerekse iç pazar bayi ağı ile değişen talepleri sürekli yenilenen zengin ürün portföyü ile karşılamaktadır.

Yüksek katma değer sağlayan yenilikçi ürün yapısı ile gelişen son teknolojiyi kullanarak kalıp üretimleri ile paslanmaz çeliğe şekil ve boyut kazandırmaktadır. Teknolojiyi ve günümüz trendlerini takip eden yenilikçi yaklaşımı ve kalip teknolojisine yaptığı yatırımı ile her tasarımına kendi imzasını atarak her geçen yıl güçlü bir marka olma yolunda güvenle ilerlemektedir.

Güvenilirlik, yetenek ve kalite zemininde ilerleyen PH DİZAYN modern, minimalist ve zengin dizaynı ile banyo ve mutfakların kimyasını değiştirmek konusunda oldukça iddialıdır.

HEMZEMİN PREMIUM DUŞ ÇÖZÜMLERİ

Temizlik, kullanım ve hijyen kolaylığı için her geçen gün farkındalıkla hemzemin duş sistemleri tercihleri artıyor. Premium serisi duş kanalları modern yıkanma alanları için kolay uygulama, fonksiyonel çözümler sunar.

Leveling shower systems preferences are increasing day by day with awareness for cleaning, usage and hygiene convenience. Premium series shower channels offer easy application and functional solutions for modern washing areas.

Mimari projeleriniz için neden PH Dizayn duş kanalları?

Patentli contasız sistem ile %100 su sızdırmazlık garantisi, Dünyada ilk ve TEK !

- Patentli V Cutting teknolojisi kullanılarak üretilen Slim ve Smartline serilerinde kapak detayında keskin hat bitişi ile seramikler ile mükemmel derzsiz birleşim.
- Farklı ebat ve renk alternatifleri ile mimari çözümler
- 8 farklı sifon alternatifi, yüksek tahliye kapasitesi ve S sifon yapısı ile kokusuz banyolar!
- Sade ve fonksiyonel detaylar ile maksimum hijyen.Kir tutmayan, detayları azaltılmış paslanmaz çelik hazne ile kolay temizlik.

Why you choose Ph Design drainage systems?

First and unique design all over the world with patented without gasket systems provide %100 waterproof.

With patented V Cutting technologies sharp finishing for cover provide perfect finish with ceramic tiles.

With different size and color options, architectural solutions.

With 8 different siphon alternatives, high drain capacity and S siphon prevent odor system.

Minimum height siphon alternatives, compact siphon for small shower area.

Maximum hygiene with simple and functional details. Easy cleaning with the stainless steel body with reduced details.



PH SLIM SAYFA : 13 / 24

- ✓ Uzunluk Alternatifi (Length Options): 40 cm, 50 cm, 60 cm, 70 cm, 80 cm, 90 cm, 120 cm.
- ✓ Genişlik Alternatifi (Width Options): 4 cm
- ✓ Sifon Alternatifi (Siphon Options): 8
- ✓ Renk Alternatifi (Color Options): 7
- ✓ Patentli contasız sistem ile %100 su sızdırmazlık garantisi. (Patented Without Gasket Systems)
- ✓ Patentli V Cutting teknolojisi ile mükemmel seramik birleşimi. (Patented V Cutting Technology)



Elegant



Trendy



Qdrain

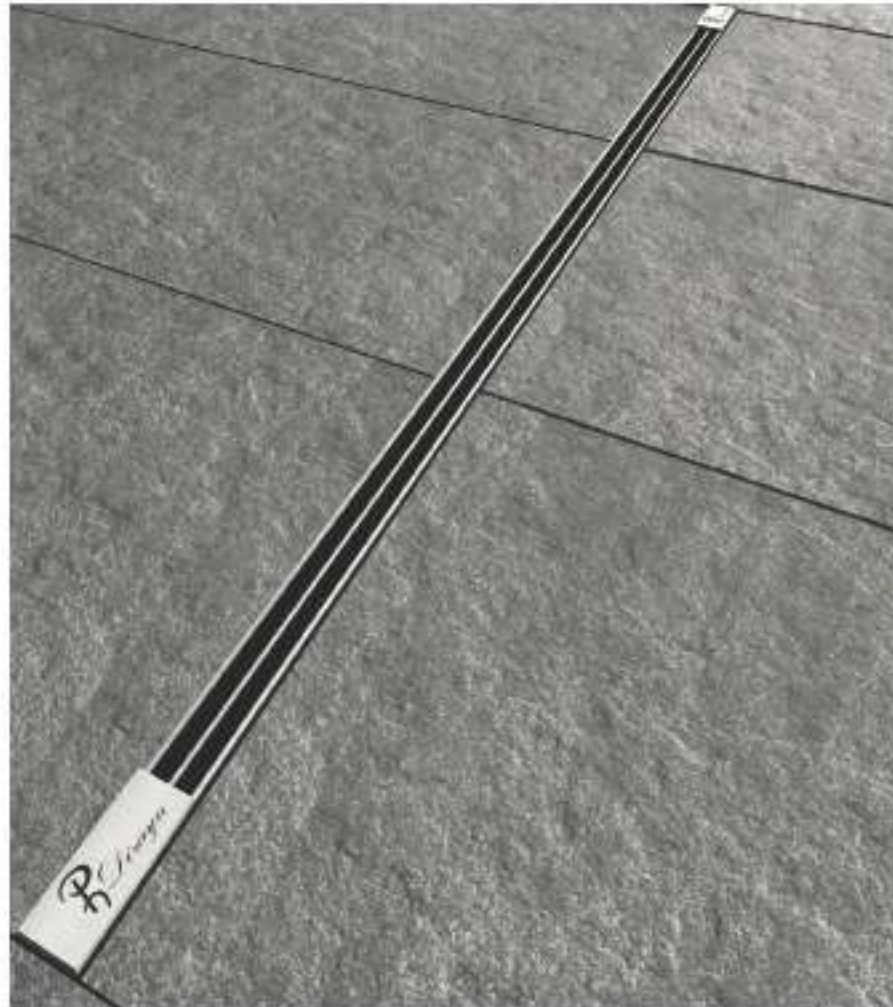

PH BALCONY & TERRACE SAYFA : 25 / 28

- ✓ Uzunluk Alternatifi (Length Options): 60 cm, 70 cm, 80 cm, 90 cm, 120 cm
- ✓ Genişlik Alternatifi (Width Options): 2,5 cm
- ✓ Sifon Alternatifi (Siphon Options): 8
- ✓ Renk Alternatifi (Color Options): 4
- ✓ Kapak Alternatifi (Cover Options): 2

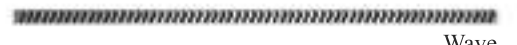

Wave



Infinity

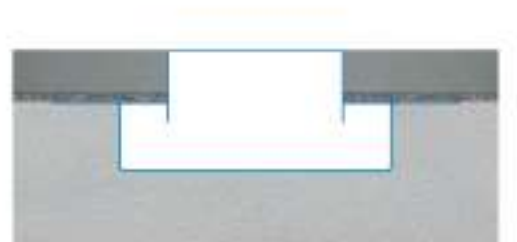

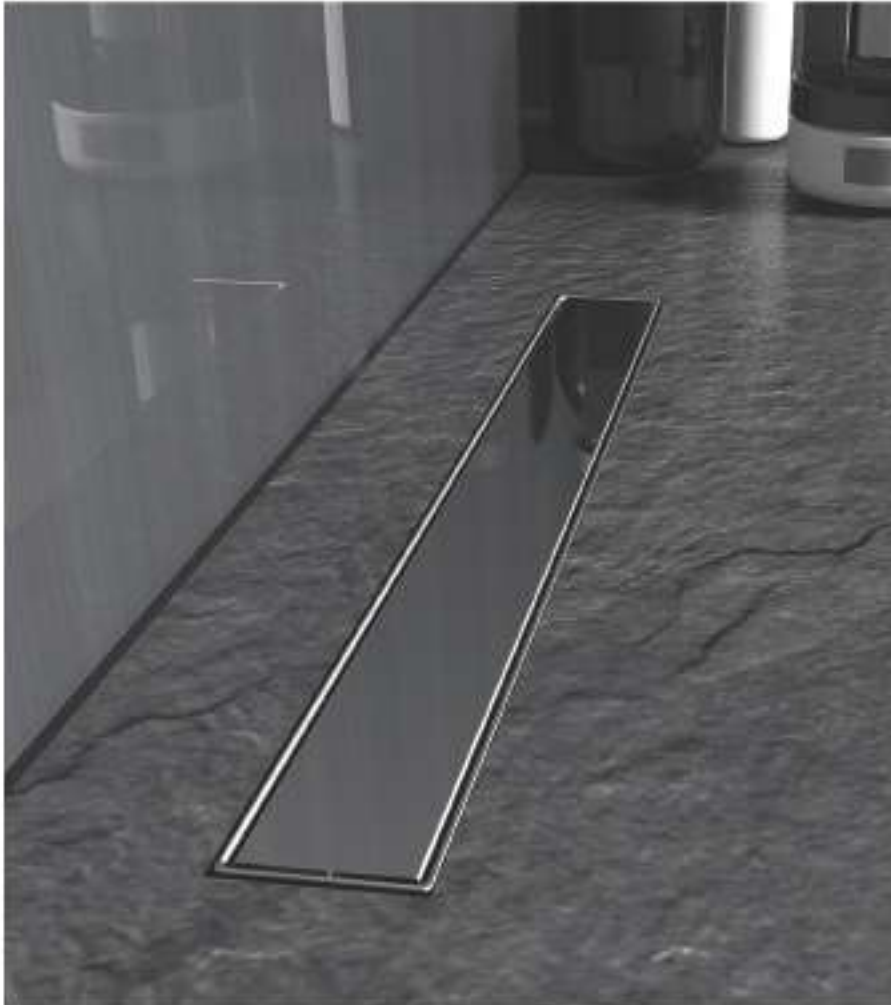

PH PREMIUM SAYFA : 29 / 52

- ✓ Uzunluk Alternatifi (Length Options): 30 cm , 40 cm , 50 cm , 60 cm , 70 cm , 80 cm , 90 cm , 100 cm , 120 cm
- ✓ Genişlik Alternatifi (Width Options): 6 cm
- ✓ Sifon Alternatifi (Siphon Options): 8
- ✓ Renk Alternatifi (Color Options): 7
- ✓ Kapak Alternatifi (Cover Options): 10
- ✓ Patentli contasız sistem ile %100 su sızdırmazlık garantisi. (Patented Without Gasket Systems)

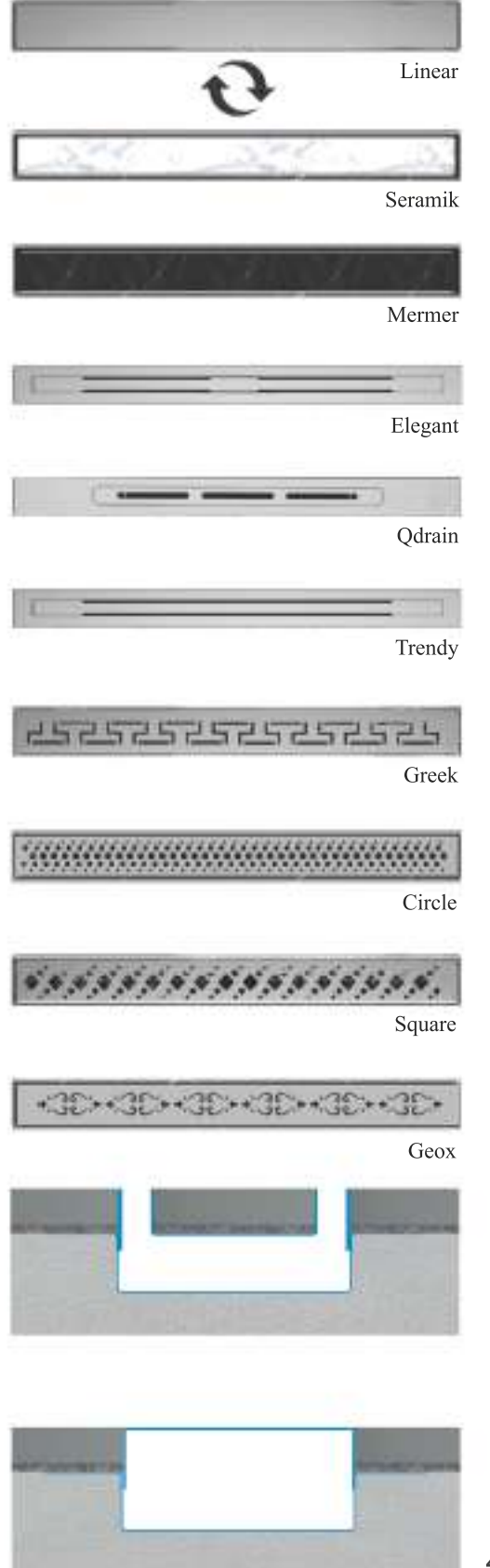

*Fiyat kataloğundaki ürün kodları S01 sifon tipine göre düzenlenmiştir. Siparişiniz esnasında seçtiğiniz sifon tipini S01 ile değiştiriniz. Sifon tiplerine göre fiyat değişmez .

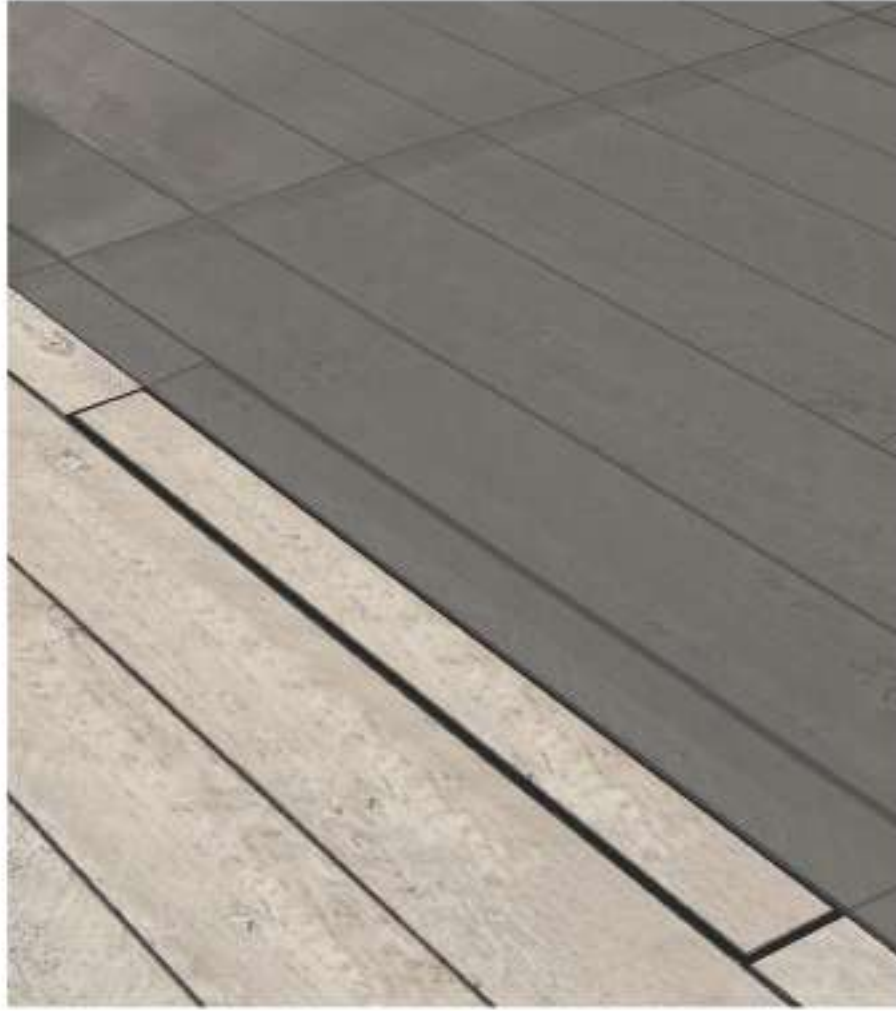

PH PRODRAIN SAYFA : 53 / 62

- ✓ Prodrain invisible serisi ile görünmez gider sistemine sahip yenilikçi ürünler.
- ✓ Uzunluk Alternatifi (Length Options): 30 cm , 40 cm , 50 cm , 60 cm , 70 cm , 80 cm , 90 cm
- ✓ Genişlik Alternatifi(Width Options): 5,5 cm
- ✓ Sifon Alternatifi (Siphon Options): 8
- ✓ Renk Alternatifi (Color Options): 7
- ✓ Kapak Alternatifi (Cover Options): 3
- ✓ Patentli contasız sistem ile %100 su sızdırmazlık garantisi.(Patented V Cutting Technology)



Linear



Greek



Invisible



PH SMARTLINE SAYFA : 63 / 76

- ✓ Uzunluk Alternatifi (Length Options):
- ✓ Linear, Qdrain, Slot: 40 cm-60cm
Smartline Trendy, Icon: 40-50-60-70-80-90-100-120cm
- ✓ Genişlik Alternatifi(Width Options): 6 cm
- ✓ Sifon Alternatifi (Siphon Options): 8
- ✓ Renk Alternatifi (Color Options): 7
- ✓ Kapak Alternatifi (Cover Options): 5
- ✓ Patentli contasız sistem ile %100 su sızdırmazlık garantisi.(Patented Without Gasket Systems)



Linear



Qdrain

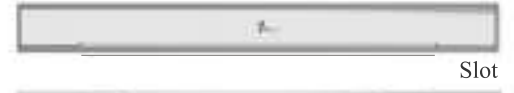

Slot

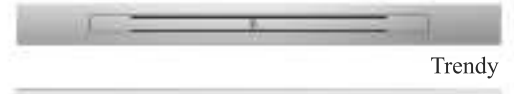

Trendy



Icon





PH COMPACTLINE

SAYFA : 77 / 84

- ✓ Uzunluk Alternatifi (Length Options): 40 cm,50 cm,60 cm,70 cm,80 cm, 90 cm, 120 cm
- ✓ Genişlik Alternatifi(Width Options): 6 cm
- ✓ Sifon Alternatifi (Siphon Options): 8
- ✓ Renk Alternatifi (Color Options): 7
- ✓ Kapak Alternatifi (Cover Options): 2
- ✓ Patentli contasız sistem ile %100 su sızdırmazlık garantisi. (Patented Without Gasket Systems)



Trendy



Icon



PH BASIC SAYFA : 85 / 88

- ✓ Uzunluk Alternatifi (Length Options): 30 cm , 40 cm , 50 cm , 60 cm , 70 cm, 80 cm , 90 cm
- ✓ Genişlik Alternatifi(Width Options): 6 cm

YER SÜZGEÇLERİ SMART

SAYFA : 89 / 97

- ✓ Ebat Alternatifi (Dimension Options): 10 x 10 cm , 15 x 15 cm
- ✓ Renk Alternatifi (Color Options): 7
- ✓ Kapak Alternatifi (Cover Options): 6



Design-1

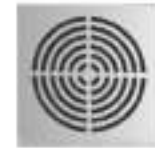

Design-2



Design-3



Design-4



Design-5



Design-6



*Fiyat kataloğundaki ürün kodları S01 sifon tipine göre düzenlenmiştir. Siparişiniz esnasında seçtiğiniz sifon tipini S01 ile değiştiriniz. Sifon tiplerine göre fiyat değişmez .

<p>PROFIX KD Syf: 101</p> 	<p>PROFIX F Syf: 102</p> 	<p>PROFIX Q Syf: 103</p> 	<p>PROFIX QE Syf: 104</p> 
<p>PROFIX D Syf: 105</p> 	<p>PROFIX DE Syf: 106</p> 	<p>PROFIX L Syf: 107</p> 	<p>PROFIX LE Syf: 108</p> 
<p>PROFIX U Syf: 109</p> 	<p>PROFIX UT Syf: 110</p> 	<p>PROFIX UE Syf: 111</p> 	<p>PROFIX C Syf: 112</p> 
<p>PROFIX 45 Syf: 113</p> 	<p>PROFIX S Syf: 114</p> 	<p>PROFIX R Syf: 115</p> 	<p>PROFIX V Syf: 116</p> 
<p>PROFIX KOT K Syf: 117</p> 	<p>PROFIX KOT Z Syf: 118</p> 	<p>PROFIX KOT N Syf: 119</p> 	<p>PROFIX T Syf: 120</p> 
<p>PROFIX G Syf: 121</p> 	<p>PROFIX E1 Syf: 122</p> 	<p>PROFIX Y Syf: 123</p> 	<p>PROFIX E2 Syf: 124</p> 
<p>PROFIX E3 Syf: 125</p> 	<p>PROFIX E4 Syf: 126</p> 	<p>PROFIX KOT A Syf: 127</p> 	<p>PROFIX LR Syf: 128</p> 
<p>PROFIX B Syf: 129</p> 	<p>PROFIX BB Syf: 130</p> 	<p>PROFIX QA Syf: 131</p> 	<p>PROFIX DK Syf: 132</p> 

LINEAR Syf: 135



LINEAR E Syf: 136



DIAMOND X Syf: 137



DIAMOND X Syf: 138



DIAMOND TILE Syf: 139



DIAMOND FORM Syf: 140



DIAMOND ART Syf: 141



DIAMOND LUX Syf: 142



DIAMOND DESIGN Syf: 143



DIAMOND SHINE Syf: 144



OTTOMAN Syf: 145



OTTOMAN DIAMOND Syf: 146



OTTOMAN DIAMOND Syf: 147



LINEAR X Syf: 148



LINEAR S Syf: 148



3d STAR W Syf: 149



3d STAR Syf: 150



3d ANGLE Syf: 151



CAPELLA Syf: 152



VENÜS Syf: 153



FLOWER Syf: 154



INFINITY R Syf: 155



INFINITY D Syf: 156



KASABLANKA S DIAMOND Syf: 157



KASABLANKA 2S DIAMOND Syf: 158



KASABLANKA 3S DIAMOND Syf: 158



LILYUM S DIAMOND Syf: 159



KARDELEN Syf: 160



KRIZANTEM Syf: 160



AÇELYA DIAMOND Syf: 161



MIMOZA DIAMOND Syf: 161



DRAGON Syf: 162



Mimari projeleriniz için neden PH Dizayn duş kanalları?

Patentli contasız sistem ile %100 su sızdırmazlık garantisi, Dünyada ilk ve TEK !

- Patentli V Cutting teknolojisi kullanılarak üretilen Slim ve Smartline serilerinde kapak detayında keskin hat bitişi ile seramikler ile mükemmel derzsiz birleşim.

- Farklı ebat ve renk alternatifleri ile mimari çözümler

- 8 farklı sifon alternatifi, yüksek tahliye kapasitesi ve S sifon yapısı ile kokusuz banyolar!

- Sade ve fonksiyonel detaylar ile maksimum hijyen.Kir tutmayan, detayları azaltılmış paslanmaz çelik hazne ile kolay temizlik.

Why you choose Ph Design drainage systems?

First and unique design all over the world with patented without gasket systems provide %100 waterproof.

With patented V Cutting technologies sharp finishing for cover provide perfect finish with ceramic tiles.

With different size and color options, architectural solutions.

With 8 different siphon alternatives, high drain capacity and S siphon prevent odor system.

Minimum height siphon alternatives, compact siphon for small shower area.

Maximum hygiene with simple and functional details. Easy cleaning with the stainless steel body with reduced details.



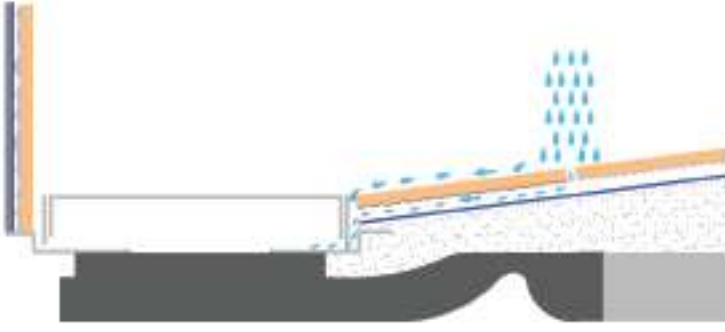

Çift Drenaj Sistemi PH DDS: Kaplama malzemesi (seramik, mermer vb.) üzerinden akan su duş zemininde drenaj kanalına tahliye olurken zamanla yıpranan derz noktalarından kaplama kotunun altına olası sızıntı riski oluşturacaktır. Bu durumda PH-DDS sistemi devreye girer ve ikincil tahliye ile sızıntıları tekrar kanala göndererek güvenli kullanım sağlar. Premium serisinde tüm sifon tiplerin PH-DDS özelliğine sahiptir.

Ph Double Drain System: While the water flowing over the coating material (ceramic, marble, etc.) is discharged from the drainage channel, there will be a risk of possible leakage from the joints that wear out over time. In this case, the PH-DDS system is activated and provides safe use by sending the leaks back to the channel with the secondary drain. All series have PH-DDS feature.



Maksimum Su Haznesi ile Göllenme Problemlerine Son! : Maksimum su toplama haznesine sahip ankastr paslanmaz gövde ile yıkanma alanlarında olası göllenme sorunlarına kesin çözüm.

Solution To Ponding Problems With Has Maximum Water Collection Reservoir! : The definitive solution to possible ponding problems in washing areas with the built-in stainless reservoir with maximum water collection reservoir.



Smartline Slot Saç Tutucu



Smartline Yuvarlak Saç Tutucu



Premium Slot Saç Tutucu



Premium Yuvarlak Saç Tutucu



Kapak Çıkartma Aparatı



Smartline Susuz Membran Koku Tutucu

Kolay Temizlik Maksimum Hijyen: Her seri için özel olarak tasarlanan saç tutucu süzgeçler ve temizleme aparatı sayesinde duş kanallarının temizliği ve hijyeni kolaylıkla sağlanır.

Easy Cleaning Maximum Hygiene: The cleaning and hygiene of the shower channels is easily achieved thanks to the specially designed hair holder strainers and cleaning apparatus.



Kolay Montaj (Ankastr Yükseklik Ayar Seti) : Tesviye betonunun yüksekliğini ayarlamak için kullanılır. Geniş alt haznesi ile beton zemini sağlam kavrar, iç yapısında bulunan yükseklik ayar parçası ile kolaylıkla tesviye betonu seviyesi ayarlanır.

Easy Installation (Built-in Height Adjustment Set) : It is used to adjust the height of the leveling concrete. With its wide bottom chamber, it grips the concrete floor firmly and the leveling concrete level is adjusted with the height adjustment part in the inner structure.



Seramik ve Mermer Uyumlu Kapak (Çift Yönlü Kullanılabilir Kapak): Paslanmaz çelik kapak aynı zamanda ters çevrilerek içine kaplama malzemeniz uygulanır. Banyonuzda bütünsel şıklık sağlar.

Ceramic and Marble Compatible Cover (Reversible Cover): The stainless steel cover is also reversed and your coating material is applied inside, providing holistic elegance in your bathroom.



Temiz Uygulama Bitişi (Kademeli Yükseklik Ayar Parçası): Patentli tasarım. Kaplama malzemesi (seramik, mermer vs.) montajı sonrasında oluşabilecek kot farklılıklarının giderilmesi sağlanır. Kademeli yapısı ve en aza indirgenmiş detayı ile montaj kolaylığının yanı sıra paslanmaz gövde içine azaltılmış detaylar ile maksimum hijyen sağlar.

Clean Application Finish (Graded Height Adjustment Piece): Patent design. Level differences that may occur after the installation coating material (ceramic, marble, etc.) are eliminated. With its gradual structure and minimized detail, it provides maximum hygiene with reduced details in the stainless body as well as ease of installation.



Patentli V Cutting Özelliği ve Derzsiz Birleşim ile Mükemmel Bitişler:

Patentli V Cutting teknolojisi ile kaplamanızla temiz birleşim detayı.

Jointless and perfect finishes with patented V Cutting technologies.

Rektifiyeli seramiklerle radüssüz birleşim detayı.

Without radius finish details with rectified tiles.



KESİLEBİLİR DUŞ KANALI: Smartline , Comfortline (Trendy ve Icon) duş kanalları istenilen ölçüde uygulama esnasında kesilerek duvardan duvara kullanılabilir.









CUTTABLE SHOWER CHANNEL: Smartline, Comfortline (Trendy and Icon shower channel can be cuttable while installation also use wall to wall.)

PH SLIM

Duř Alanlarında Fonksiyonel Çözümler: Mimari projeleriniz için eşsiz tasarım seçenekleri sunar.

Functional Solutions In Shower Areas: Offers unique design options for your architectural projects.

PH SLIM

 360° base rotation	 60 mm	 Ø50 output	 304 stainless steel
 + easy to clean	 odor prevent system	 51l/min	 easy assembling

SLIM

DRAINLINE

Ph Dizayn

Uygulama Kesit :

1. Döşeme Betonu / Covering Concrete
2. Tesviye Betonu / Levelling Concrete
3. Ph Dizayn Butil Bant / Ph Design Butil Bant
4. İzolasyon Katmanı / Insulation Layer
5. Yapıştırıcı / Adhesive
6. Kaplama Malzemesi / Covering

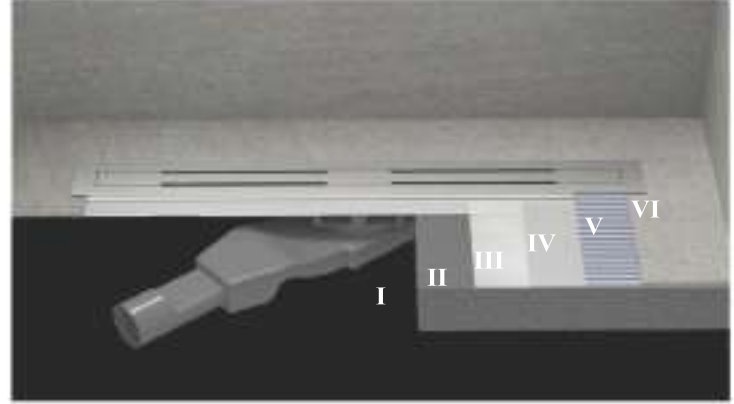

Sifon Tipi : S01

Kapak (1.5 mm kalınlık) / Top cover (1.5 mm)

Yükseklik Ayar Çerçevesi(2.5 mm) /Final height adjustment Frame(2.5 mm)

Yükseklik Ayar Vidası / Height Adjustment Screw

Saç Tutucu Süzgeç / Hair Holder

Yalıtım Etekli Ana Gövde / Insulated Main Body

Patentli Contasız Bağlantı Parçası / Patented Without Gasket Part

360° Döner Sifon S01 / 360° Degree Rotating Flusher

Yükseklik Ayar Parçası / Height Adjustment Kit



15

S01



S13



S15



S16

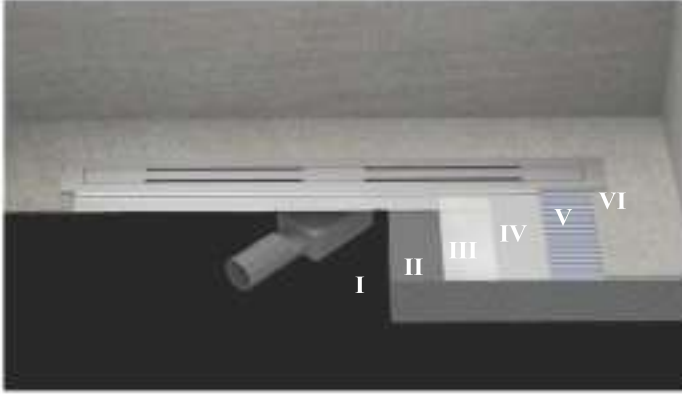

Uygulama Kesit :

1. Döşeme Betonu / Covering Concrete
2. Tesviye Betonu / Levelling Concrete
3. Ph Dizayn Butil Bant / Ph Design Butil Bant
4. İzolasyon Katmanı / Insulation Layer
5. Yapıştırıcı / Adhesive
6. Kaplama Malzemesi / Covering

Sifon Tipi : S02



S02



S03



S11



S14



Renovasyon ve yeni yapı projeleriniz için neden PH Dizayn duş kanalları?

Patentli contasız sistem ile %100 su sızdırmazlık garantisi, Dünyada ilk ve TEK !

- Patentli V Cutting teknolojisi kullanılarak üretilen Slim ve Premium serilerinde kapak detayında keskin hat bitişi ile seramikler ile mükemmel derzsiz birleşim.
- Farklı ebat ve renk alternatifleri ile mimari çözümler
- 8 farklı sifon alternatifi, yüksek tahliye kapasitesi ve S sifon yapısı ile kokusuz banyolar!
- Sade ve fonksiyonel detaylar ile maksimum hijyen.Kir tutmayan, detayları azaltılmış paslanmaz çelik hazne ile kolay temizlik.

Why you choose ph design drainage systems?

First and unique design all over the world with patented without gasket systems provide %100 waterproof.

With patented V Cutting technologies sharp finishing for cover provide perfect finish with ceramic tiles.

With different size and color options, architectural solutions.

With 8 different siphon alternatives, high drain capacity and S siphon prevent odor system.

Minimum height siphon alternatives, compact siphon for small shower area.

Maximum hygiene with simple and functional details. Easy cleaning with the stainless steel body with reduced details.

SLIM
ELEGANT

DRAINLINE

PH
Dizayn

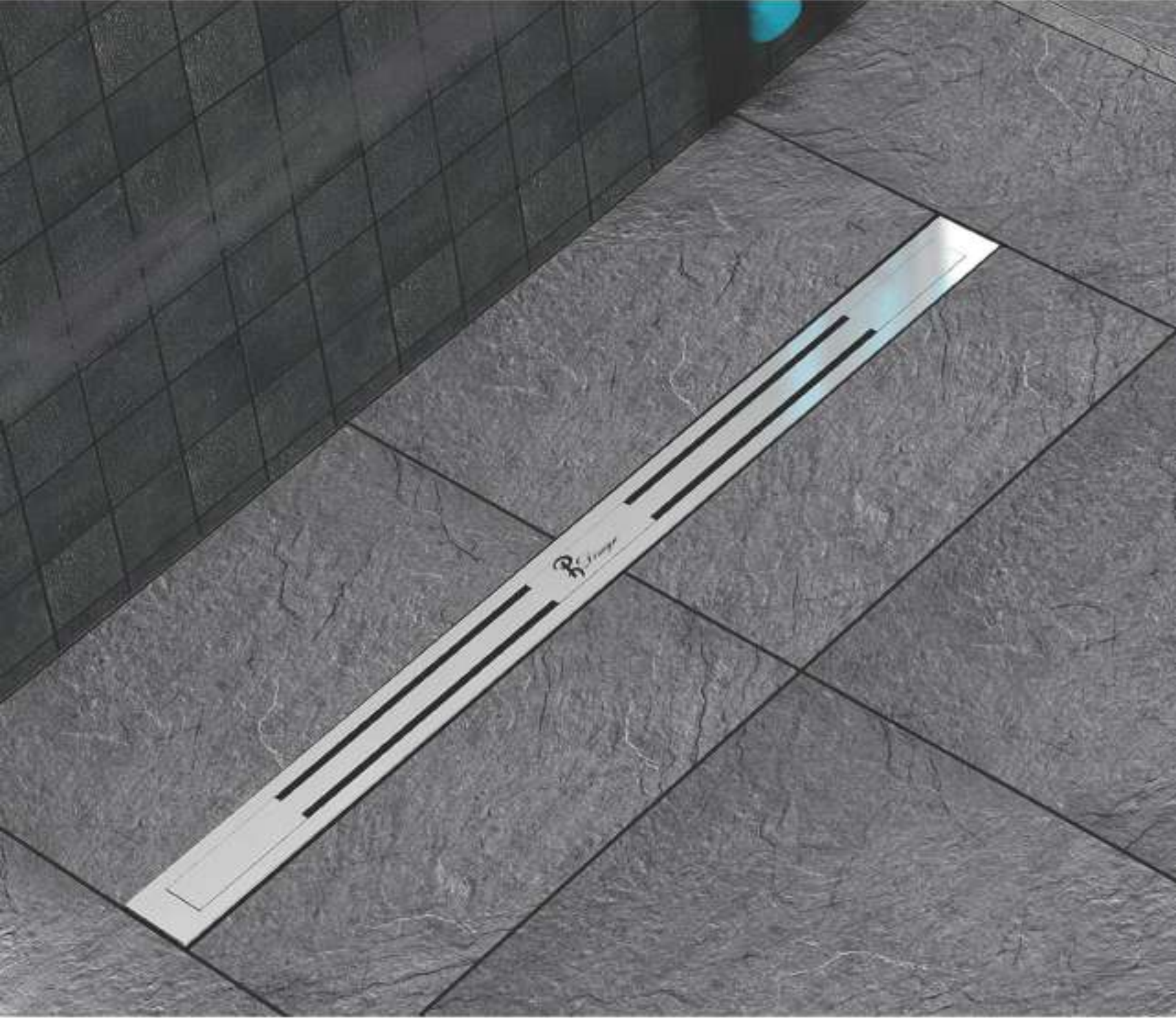

PH DESIGN

Slim Serisi ile duş alanlarına modern , estetik ve kullanışlı çözümler sunuyor. Hemzemin uygulama karo ile bütünleşerek engelsiz banyolar yaratıyor. Yeni teknolojiyi kullanarak PATENTLİ CONTASIZ sistem ile sızdırmalıkta standartları yeniden belirliyor.

Slim Serisi Ürünler;

-Yalıtım etekli kaynaklı yekpare gövde, şap yüksekliğini için yükseklik ayar seti, farklı montaj yükseklikleri ve drenaj kapasiteleri ile projelere uygun alternatif mekanik çözümler sunan, 360 derece dönebilen yüksek drenaj kapasiteli koku fermatürlü S sifon, saç tutucu, 20 cm genişliğinde bütül bant, uygulama sonrası oluşabilecek kot farklılıklarını önleyen yükseklik ayar setini uygulama

19 kolaylığı sağlayacak şekilde standardize ederek, tek parça ürün olarak birleştiriyor ve kullanıcılara kolay montaj avantajı sunuyor.

EBAT Size	Inox Satinox		Satine Altın Satin Gold		Satine Bakır Satin Bronze		Siyah Black	
40 cm	DS 040 01 07 S01	140 \$	DS 040 21 07 S01	237 \$	DS 040 31 07 S01	261 \$	DS 040 55 07 S01	237 \$
50 cm	DS 050 01 07 S01	158 \$	DS 050 21 07 S01	255 \$	DS 050 31 07 S01	279 \$	DS 050 55 07 S01	255 \$
60 cm	DS 060 01 07 S01	174 \$	DS 060 21 07 S01	271 \$	DS 060 31 07 S01	295 \$	DS 060 55 07 S01	271 \$
70 cm	DS 070 01 07 S01	200 \$	DS 070 21 07 S01	297 \$	DS 070 31 07 S01	321 \$	DS 070 55 07 S01	297 \$
80 cm	DS 080 01 07 S01	213 \$	DS 080 21 07 S01	344 \$	DS 080 31 07 S01	377 \$	DS 080 55 07 S01	344 \$
90 cm	DS 090 01 07 S01	239 \$	DS 090 21 07 S01	433 \$	DS 090 31 07 S01	481 \$	DS 090 55 07 S01	433 \$
120 cm	DS 120 01 07 S01	293 \$	DS 120 21 07 S01	487 \$	DS 120 31 07 S01	535 \$	DS 120 55 07 S01	487 \$

EBAT Size	Inox Ayna Inox Mirror		Altın Ayna Gold Mirror		Bakır Ayna Bronze Mirror	
40 cm	DS 040 00 07 S01	168 \$	DS 040 20 07 S01	237 \$	DS 040 30 07 S01	261 \$
50 cm	DS 050 00 07 S01	190 \$	DS 050 20 07 S01	255 \$	DS 050 30 07 S01	279 \$
60 cm	DS 060 00 07 S01	201 \$	DS 060 20 07 S01	271 \$	DS 060 30 07 S01	295 \$
70 cm	DS 070 00 07 S01	225 \$	DS 070 20 07 S01	297 \$	DS 070 30 07 S01	321 \$
80 cm	DS 080 00 07 S01	232 \$	DS 080 20 07 S01	344 \$	DS 080 30 07 S01	377 \$
90 cm	DS 090 00 07 S01	265 \$	DS 090 20 07 S01	433 \$	DS 090 30 07 S01	481 \$
120 cm	DS 120 00 07 S01	332 \$	DS 120 20 07 S01	487 \$	DS 120 30 07 S01	535 \$



Size uygun sifon tipini siparişiniz esnasında ürün koduna ekleyiniz.
Please add the siphon type to the product code in your order.

S01

h : 60 mm
Debi: 42 lt/dk - Flow: 42 lt/min
Kokusuz / Odor free



S02

h : 70 mm
Debi: 48 lt/dk - Flow: 48 lt/min
Kokusuz / Odor free



S03

h : 30/80 mm
Karat ø: 120mm - Care Drill Diameter ø: 120mm
Debi: 48 lt/dk - Flow: 48 lt/min
Kokusuz / Odor free



S11

h : 60 mm
Debi: 42 lt/dk - Flow: 42 lt/min
Kokusuz / Odor free



S13

h : 60 mm
Karat ø: 110 mm - Care Drill Diameter ø: 110 mm
Debi: 48 lt/dk - Flow: 48 lt/min
Kokusuz / Odor free



S14

h : 80 mm
Debi: 60 lt/dk - Flow: 60 lt/min
Kokusuz / Odor free



S15

h : 60 mm
Debi: 42 lt/dk - Flow: 42 lt/min
Kokusuz / Odor free



S16

h : 80 mm
Debi: 60 lt/dk - Flow: 60 lt/min
Kokusuz / Odor free



SLIM
QDRAIN

DRAINLINE

PH
Dizayn



PH DESIGN

Slim serisi ile duř alanlarına modern , estetik ve kullanışlı çözümler sunuyor. Hemzemin uygulama karo ile bütünleşerek engelsiz banyolar yaratıyor. Yeni teknolojiyi kullanarak PATENTLİ CONTASIZ sistem ile sızdırmalıkta standartları yeniden belirliyor.

Slim serisi ürünler;

-Yalıtım etekli kaynaksız yekpare gövde, şap yüksekliğini için yükseklik ayar seti, farklı montaj yükseklikleri ve drenaj kapasiteleri ile projelere uygun alternatif mekanik çözümler sunan, 360 derece dönebilen yüksek drenaj kapasiteli koku fermatürlü S sifon, saç tutucu, 20 cm genişliğinde bütül bant, uygulama sonrası oluşabilecek kot farklılıklarını önleyen yükseklik ayar setini uygulama kolaylığı sağlayacak şekilde standardize ederek, tek parça ürün olarak birleştiriyor ve kullanıcılara kolay montaj avantajı sunuyor.

EBAT Size	Inox Satinox		Satine Altın Satin Gold		Satine Bakır Satin Bronze		Siyah Black	
40 cm	DS 040 01 08 S01	140 \$	DS 040 21 08 S01	237 \$	DS 040 31 08 S01	261 \$	DS 040 55 08 S01	237 \$
50 cm	DS 050 01 08 S01	158 \$	DS 050 21 08 S01	255 \$	DS 050 31 08 S01	279 \$	DS 050 55 08 S01	255 \$
60 cm	DS 060 01 08 S01	174 \$	DS 060 21 08 S01	271 \$	DS 060 31 08 S01	295 \$	DS 060 55 08 S01	271 \$
70 cm	DS 070 01 08 S01	200 \$	DS 070 21 08 S01	297 \$	DS 070 31 08 S01	321 \$	DS 070 55 08 S01	297 \$
80 cm	DS 080 01 08 S01	213 \$	DS 080 21 08 S01	344 \$	DS 080 31 08 S01	377 \$	DS 080 55 08 S01	344 \$
90 cm	DS 090 01 08 S01	239 \$	DS 090 21 08 S01	433 \$	DS 090 31 08 S01	481 \$	DS 090 55 08 S01	433 \$
120 cm	DS 120 01 08 S01	293 \$	DS 120 21 08 S01	487 \$	DS 120 31 08 S01	535 \$	DS 120 55 08 S01	487 \$

EBAT Size	Inox Ayna Inox Mirror		Altın Ayna Gold Mirror		Bakır Ayna Bronze Mirror	
40 cm	DS 040 00 08 S01	168 \$	DS 040 20 08 S01	237 \$	DS 040 30 08 S01	261 \$
50 cm	DS 050 00 08 S01	190 \$	DS 050 20 08 S01	255 \$	DS 050 30 08 S01	279 \$
60 cm	DS 060 00 08 S01	201 \$	DS 060 20 08 S01	271 \$	DS 060 30 08 S01	295 \$
70 cm	DS 070 00 08 S01	225 \$	DS 070 20 08 S01	297 \$	DS 070 30 08 S01	321 \$
80 cm	DS 080 00 08 S01	232 \$	DS 080 20 08 S01	344 \$	DS 080 30 08 S01	377 \$
90 cm	DS 090 00 08 S01	265 \$	DS 090 20 08 S01	433 \$	DS 090 30 08 S01	481 \$
120 cm	DS 120 00 08 S01	332 \$	DS 120 20 08 S01	487 \$	DS 120 30 08 S01	535 \$



Size uygun sifon tipini siparişiniz esnasında ürün koduna ekleyiniz.
Please add the siphon type to the product code in your order.

S01

h : 60 mm
Debi: 42 lt/dk - Flow: 42 lt/min
Kokusuz / Odor free



S02

h : 70 mm
Debi: 48 lt/dk - Flow: 48 lt/min
Kokusuz / Odor free



S03

h : 30/80 mm
Karat ø: 120mm - Care Drill Diameter ø: 120mm
Debi : 48 lt/dk - Flow: 48 lt/dk
Kokusuz / Odor free



S11

h : 60 mm
Debi: 42 lt/dk - Flow: 42 lt/min
Kokusuz / Odor free



S13

h : 60 mm
Karat ø: 110 mm - Care Drill Diameter ø: 110 mm
Debi: 48 lt/dk - Flow: 48 lt/min
Kokusuz / Odor free



S14

h : 80 mm
Debi: 60 lt/dk - Flow: 60 lt/dk
Kokusuz / Odor free



S15

h : 60 mm
Debi: 42 lt/dk - Flow: 42 lt/min
Kokusuz / Odor free



S16

h : 80 mm
Debi: 60 lt/dk - Flow: 60 lt/min
Kokusuz / Odor free



SLIM
TRENDY

DRAINLINE

PH
Dizayn

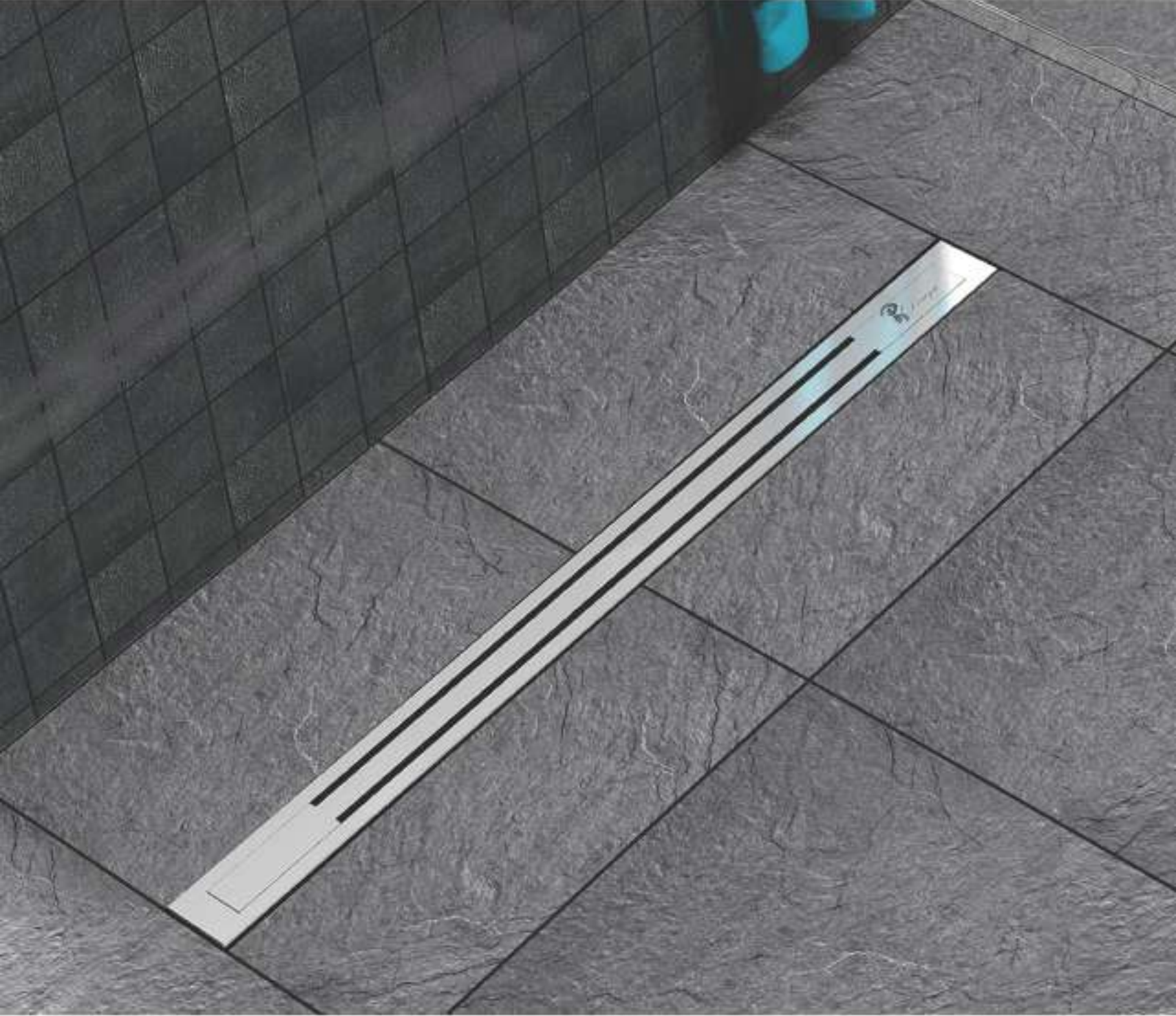

PH DESIGN

Slim serisi ile duş alanlarına modern , estetik ve kullanışlı çözümler sunuyor. Hemzemin uygulama karo ile bütünleşerek engelsiz banyolar yaratıyor. Yeni teknolojiyi kullanarak PATENTLİ CONTASIZ sistem ile sızdırmalıkta standartları yeniden belirleniyor.

Slim serisi ürünler;

-Yalıtım etekli kaynaklı yekpare gövde, şap yüksekliğini için yükseklik ayar seti, farklı montaj yükseklikleri ve drenaj kapasiteleri ile projelere uygun alternatif mekanik çözümler sunan, 360 derece dönebilen yüksek drenaj kapasiteli koku fermatürlü S sifon, saç tutucu, 20 cm genişliğinde bütül bant, uygulama sonrası oluşabilecek kot farklılıklarını önleyen yükseklik ayar setini uygulama

EBAT Size	Inox Satinox		Satine Altın Satin Gold		Satine Bakır Satin Bronze		Siyah Black	
40 cm	DS 040 01 09 S01	140 \$	DS 040 21 09 S01	237 \$	DS 040 31 09 S01	261 \$	DS 040 55 09 S01	237 \$
50 cm	DS 050 01 09 S01	158 \$	DS 050 21 09 S01	255 \$	DS 050 31 09 S01	279 \$	DS 050 55 09 S01	255 \$
60 cm	DS 060 01 09 S01	174 \$	DS 060 21 09 S01	271 \$	DS 060 31 09 S01	295 \$	DS 060 55 09 S01	271 \$
70 cm	DS 070 01 09 S01	200 \$	DS 070 21 09 S01	297 \$	DS 070 31 09 S01	321 \$	DS 070 55 09 S01	297 \$
80 cm	DS 080 01 09 S01	213 \$	DS 080 21 09 S01	344 \$	DS 080 31 09 S01	377 \$	DS 080 55 09 S01	344 \$
90 cm	DS 090 01 09 S01	239 \$	DS 090 21 09 S01	433 \$	DS 090 31 09 S01	481 \$	DS 090 55 09 S01	433 \$
120 cm	DS 120 01 09 S01	293 \$	DS 120 21 09 S01	487 \$	DS 120 31 09 S01	535 \$	DS 120 55 09 S01	487 \$

EBAT Size	Inox Ayna Inox Mirror		Altın Ayna Gold Mirror		Bakır Ayna Bronze Mirror	
40 cm	DS 040 00 09 S01	168 \$	DS 040 20 09 S01	237 \$	DS 040 30 09 S01	261 \$
50 cm	DS 050 00 09 S01	190 \$	DS 050 20 09 S01	255 \$	DS 050 30 09 S01	279 \$
60 cm	DS 060 00 09 S01	201 \$	DS 060 20 08 S01	271 \$	DS 060 30 09 S01	295 \$
70 cm	DS 070 00 09 S01	225 \$	DS 070 20 09 S01	297 \$	DS 070 30 09 S01	321 \$
80 cm	DS 080 00 09 S01	232 \$	DS 080 20 09 S01	344 \$	DS 080 30 09 S01	377 \$
90 cm	DS 090 00 09 S01	265 \$	DS 090 20 09 S01	433 \$	DS 090 30 09 S01	481 \$
120 cm	DS 120 00 09 S01	332 \$	DS 120 20 09 S01	487 \$	DS 120 30 09 S01	535 \$



Size uygun sifon tipini siparişiniz esnasında ürün koduna ekleyiniz.
Please add the siphon type to the product code in your order.

S01

h : 60 mm
Debi: 42 lt/dk - Flow: 42 lt/min
Kokusuz / Odor free



S02

h : 70 mm
Debi: 48 lt/dk - Flow: 48 lt/min
Kokusuz / Odor free



S03

h : 30/80 mm
Karat ø: 120mm - Care Drill Diameter ø: 120mm
Debi : 48 lt/dk - Flow: 48 lt/dk
Kokusuz / Odor free



S11

h : 60 mm
Debi: 42 lt/dk - Flow: 42 lt/min
Kokusuz / Odor free



S13

h : 60 mm
Karat ø: 110 mm - Care Drill Diameter ø: 110 mm
Debi: 48 lt/dk - Flow: 48 lt/min
Kokusuz / Odor free



S14

h : 80 mm
Debi : 60 lt/dk - Flow: 60 lt/dk
Kokusuz / Odor free



S15

h : 60 mm
Debi: 42 lt/dk - Flow: 42 lt/min
Kokusuz / Odor free



S16

h : 80 mm
Debi: 60 lt/dk - Flow: 60 lt/min
Kokusuz / Odor free



S50/S95









Sifonsuz Direkt Bağlantı
(Direct Connection Without Siphon)
S50 for 2 inc (50 mm)
S95 for 4 inc (90 mm-110 mm)



PH BALCONY & TERRACE

En ince kanal ile hem dış mekan hemde yıkanma alanlarına yönelik yüksek drenaj kapasitesi ile teknik çözümler.

Technical solutions with the thinnest channel for both outdoor and bathing areas with high drainage capacity.

 360° base rotation	 60 mm	 Ø50 output	 easy assembling
 easy to clean	 odor prevent system	 51l/min	 304 stainless steel

BALCONY
&
TERRACE
WAVE

DRAINLINE

R Dizayn

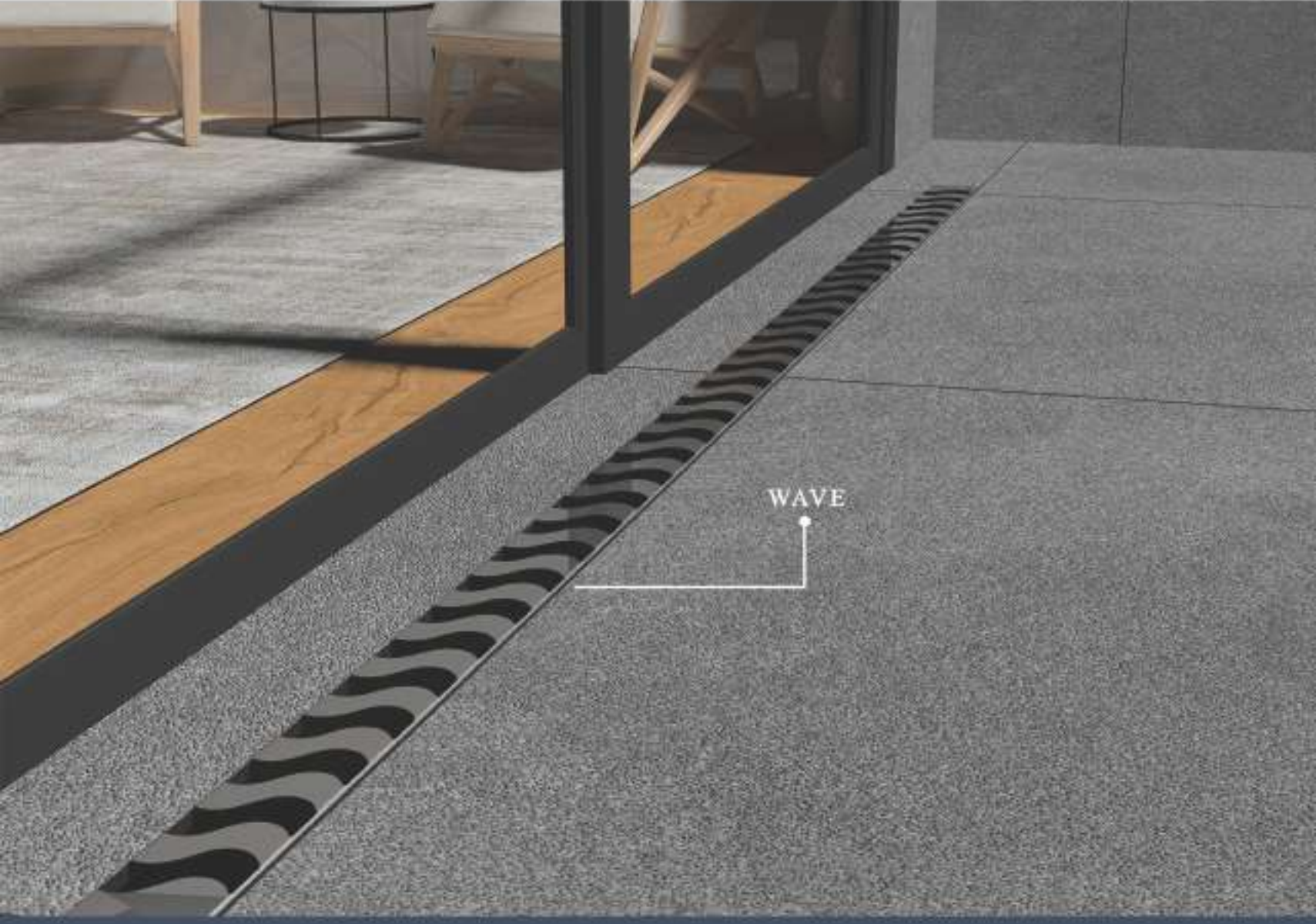

EBAT Size	Inox Satinox		Satine Altın Satin Gold		Satine Bakır Satin Bronze		Siyah Black	
60 cm	DT 060 01 19 S01	174 \$	DT 060 21 19 S01	271 \$	DT 060 31 19 S01	295 \$	DT 060 55 19 S01	271 \$
70 cm	DT 070 01 19 S01	200 \$	DT 070 21 19 S01	297 \$	DT 070 31 19 S01	321 \$	DT 070 55 19 S01	297 \$
80 cm	DT 080 01 19 S01	213 \$	DT 080 21 19 S01	344 \$	DT 080 31 19 S01	377 \$	DT 080 55 19 S01	344 \$
90 cm	DT 090 01 19 S01	293 \$	DT 090 21 19 S01	487 \$	DT 090 31 19 S01	535 \$	DT 090 55 19 S01	487 \$
120 cm	DT 120 01 19 S01	337 \$	DT 120 21 19 S01	531 \$	DT 120 31 19 S01	579 \$	DT 120 55 19 S01	531 \$

Size uygun sifon tipini siparişiniz esnasında ürün koduna ekleyiniz.
Please add the siphon type to the product code in your order.



PH INFINITY

EBAT Size	Inox Satinox		Satine Altın Satin Gold		Satine Bakır Satin Bronze		Siyah Black	
60 cm	DT 060 01 20 S01	174 \$	DT 060 21 20 S01	271 \$	DT 060 31 20 S01	295 \$	DT 060 55 20 S01	271 \$
70 cm	DT 070 01 20 S01	200 \$	DT 070 21 20 S01	297 \$	DT 070 31 20 S01	321 \$	DT 070 55 20 S01	297 \$
80 cm	DT 080 01 20 S01	213 \$	DT 080 21 20 S01	344 \$	DT 080 31 20 S01	377 \$	DT 080 55 20 S01	344 \$
90 cm	DT 090 01 20 S01	293 \$	DT 090 21 20 S01	487 \$	DT 090 31 20 S01	535 \$	DT 090 55 20 S01	487 \$
120 cm	DT 120 01 20 S01	337 \$	DT 120 21 20 S01	531 \$	DT 120 31 20 S01	579 \$	DT 120 55 20 S01	531 \$









PH PREMIUM

Renovasyon ve her türlü yeni bina projeleriniz için tasarlandı. Tüm mekanik ve tasarım beklentilerini karşılayan teknik detaylar ve fonksiyonel çözümler. Sahip olduğu 8 farklı sifon ve 9 farklı ebat seçeneği ile ihtiyacınızdan fazlasını sunar.

Designed for renovation and all kinds of new building projects. Technical details and functional solutions that meet all mechanical and design expectations. It's 8 different siphons offer more than you need with 9 different size options.

Sade ve fonksiyonel detaylar ile maksimum hijyen. Kir tutmayan, detayları azaltılmış, paslanmaz çelik hazne ile kolay temizlik.

Maximum hygiene with simple and functional details. easy cleaning with stainless steel body with reduced details.

PREMIUM

DRAINLINE

Ph Dizayn

Uygulama Kesit :

1. Döşeme Betonu / Covering Concrete
2. Tesviye Betonu / Levelling Concrete
3. Ph Dizayn Butil Bant / Ph Design Butil Bant
4. İzolasyon Katmanı / Insulation Layer
5. Yapıştırıcı / Adhesive
6. Kaplama Malzemesi / Covering

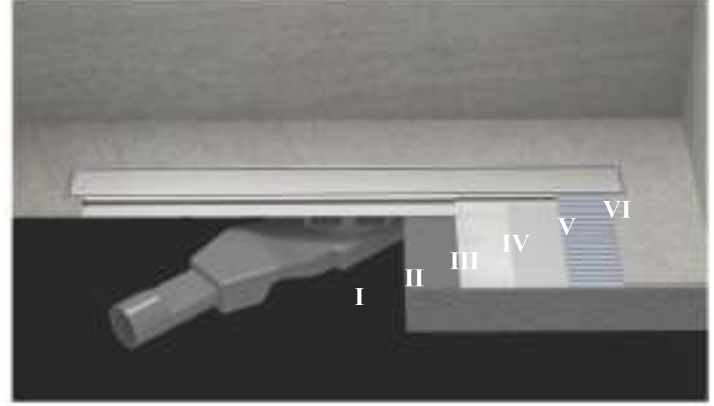

Sifon Tipi : S01

Kapak (1.5 mm kalınlık) / Top cover (1.5 mm)

Yükseklik Ayar Çerçevesi(2.5mm)/Final height adjustment frame(2.5mm)

Kademeli Yükseklik Ayar Vidası / Gradual Height Adjustment Screw

Saç Tutucu Süzgeç / Hair Holder

Yalıtım Etekli Ana Gövde / Insulated Main Body

Patentli Contasız Bağlantı Parçası / Patented Without Gasket Part

Yükseklik Ayar Parçası / Height Adjustment Kit

360° Döner Sifon S01 / 360° Degree Rotating Flusher



31

S01



S13



S15



S16

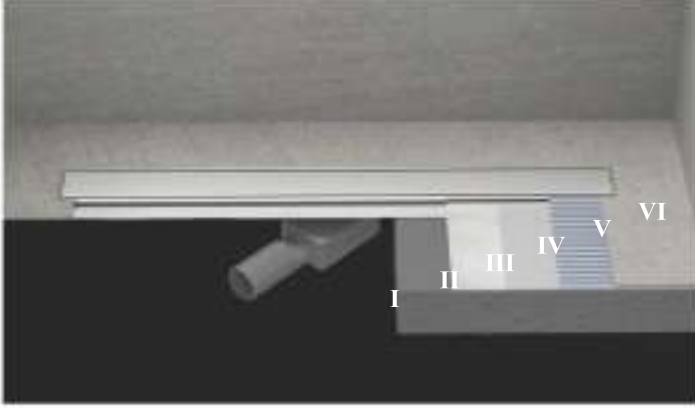

Uygulama Kesit :

1. Döşeme Betonu / Covering Concrete
2. Tesviye Betonu / Levelling Concrete
3. Ph Dizayn Butil Bant / Ph Design Butil Bant
4. İzolasyon Katmanı / Insulation Layer
5. Yapıştırıcı / Adhesive
6. Kaplama Malzemesi / Covering

Sifon Tipi : S02

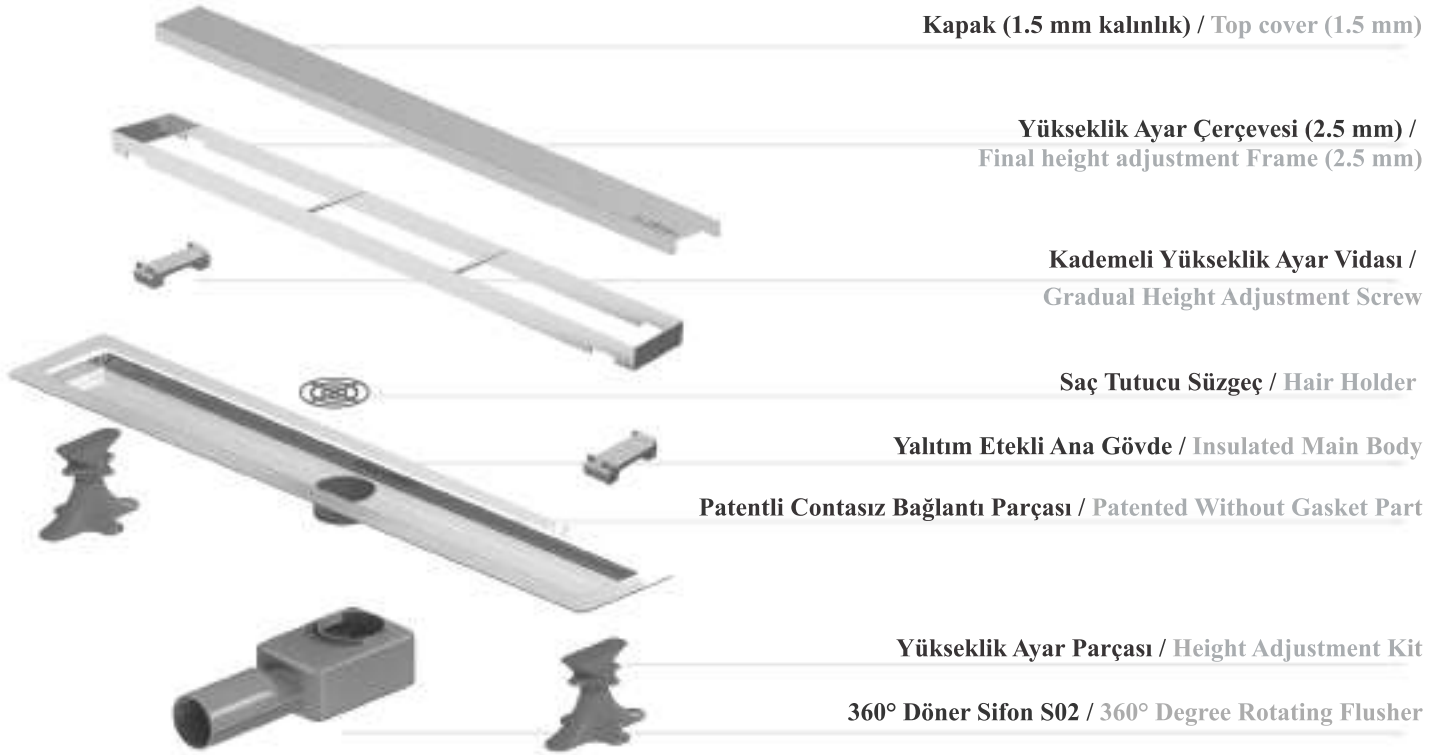

S02



S03



S11



S14

PREMIUM
LINEAR
TILEABLE

DRAINLINE

PH Design



PH DESIGN

Premium serisi ile duř alanlarına modern , estetik ve kullanıřlı çözümler sunuyor. Hemzemin uygulama karo ile bütünleřerek engelsiz banyolar yaratıyor. Yeni teknolojiyi kullanarak PATENTLİ CONTASIZ sistem ile sızdırmalıktaki standartları yeniden belirleniyor.

Premium serisi ürünler;

-Yalıtım etekli kaynaklız yekpare gövde, řap yüksekliđini için yükseklik ayar seti, farklı montaj yükseklikleri ve drenaj kapasiteleri ile projelere uygun alternatif mekanik çözümler sunan, 360 derece dönebilen yüksek drenaj kapasiteli koku fermatürlü S sifon, saç tutucu, 20 cm geniřliđinde bütöl bant, uygulama sonrası oluřabilecek kot farklılıklarını önleyen yükseklik ayar setini uygulama kolaylıđı sađlayacak řekilde standardize ederek, tek parça ürün olarak birleřtiriyor ve kullanıcılara kolay montaj avantajı sunuyor.

EBAT Size	Inox Satinox		Satine Altın Satin Gold		Satine Bakır Satin Bronze		Siyah Black	
30 cm	DP 030 01 00 S01	105 \$	DP 030 21 00 S01	202 \$	DP 030 31 00 S01	226 \$	DP 030 55 00 S01	202 \$
40 cm	DP 040 01 00 S01	122 \$	DP 040 21 00 S01	219 \$	DP 040 31 00 S01	243 \$	DP 040 55 00 S01	219 \$
50 cm	DP 050 01 00 S01	136 \$	DP 050 21 00 S01	233 \$	DP 050 31 00 S01	257 \$	DP 050 55 00 S01	233 \$
60 cm	DP 060 01 00 S01	151 \$	DP 060 21 00 S01	248 \$	DP 060 31 00 S01	272 \$	DP 060 55 00 S01	248 \$
70 cm	DP 070 01 00 S01	166 \$	DP 070 21 00 S01	263 \$	DP 070 31 00 S01	287 \$	DP 070 55 00 S01	263 \$
80 cm	DP 080 01 00 S01	185 \$	DP 080 21 00 S01	316 \$	DP 080 31 00 S01	349 \$	DP 080 55 00 S01	316 \$
90 cm	DP 090 01 00 S01	211 \$	DP 090 21 00 S01	405 \$	DP 090 31 00 S01	453 \$	DP 090 55 00 S01	405 \$
120 cm	DP 120 01 00 S01	255 \$	DP 120 21 00 S01	449 \$	DP 120 31 00 S01	497 \$	DP 120 55 00 S01	449 \$

EBAT Size	Inox Ayna Inox Mirror		Altın Ayna Gold Mirror		Bakır Ayna Bronze Mirror	
30 cm	DP 030 00 00 S01	118 \$	DP 030 20 00 S01	202 \$	DP 030 30 00 S01	226 \$
40 cm	DP 040 00 00 S01	146 \$	DP 040 20 00 S01	219 \$	DP 040 30 00 S01	243 \$
50 cm	DP 050 00 00 S01	161 \$	DP 050 20 00 S01	233 \$	DP 050 30 00 S01	257 \$
60 cm	DP 060 00 00 S01	175 \$	DP 060 20 00 S01	248 \$	DP 060 30 00 S01	272 \$
70 cm	DP 070 00 00 S01	185 \$	DP 070 20 00 S01	263 \$	DP 070 30 00 S01	287 \$
80 cm	DP 080 00 00 S01	202 \$	DP 080 20 00 S01	316 \$	DP 080 30 00 S01	349 \$
90 cm	DP 090 00 00 S01	224 \$	DP 090 20 00 S01	405 \$	DP 090 30 00 S01	453 \$
120 cm	DP 120 00 00 S01	289 \$	DP 120 20 00 S01	449 \$	DP 120 30 00 S01	497 \$



Size uygun sifon tipini siparişiniz esnasında ürün koduna ekleyiniz.
Please add the siphon type to the product code in your order.

S01

h : 60 mm
Debi: 42 lt/dk - Flow: 42 lt/min
Kokusuz / Odor free



S02

h : 70 mm
Debi: 48 lt/dk - Flow: 48 lt/min
Kokusuz / Odor free



S03

h : 30/80 mm
Kerot ø: 120mm - Core Drill Diameter ø: 120mm
Debi : 48 lt/dk - Flow: 48 lt/dk
Kokusuz / Odor free



S11

h : 60 mm
Debi: 42 lt/dk - Flow: 42 lt/min
Kokusuz / Odor free



S13

h : 60 mm
Kerot ø: 110 mm - Core Drill Diameter ø: 110 mm
Debi: 48 lt/dk - Flow: 48 lt/min
Kokusuz / Odor free



S14

h : 80 mm
Debi : 60 lt/dk - Flow: 60 lt/dk
Kokusuz / Odor free



S15

h : 60 mm
Debi: 42 lt/dk - Flow: 42 lt/min
Kokusuz / Odor free



S16

h : 80 mm
Debi: 60 lt/dk - Flow: 60 lt/min
Kokusuz / Odor free



S50/S95

Sifonsuz Direkt Bağlantı
(Direct Connection Without Siphon)
S50 for 2 inc (50 mm)
S95 for 4 inc (90 mm-110 mm)



PREMIUM
MERMER

DRAINLINE

PH
Dizayn

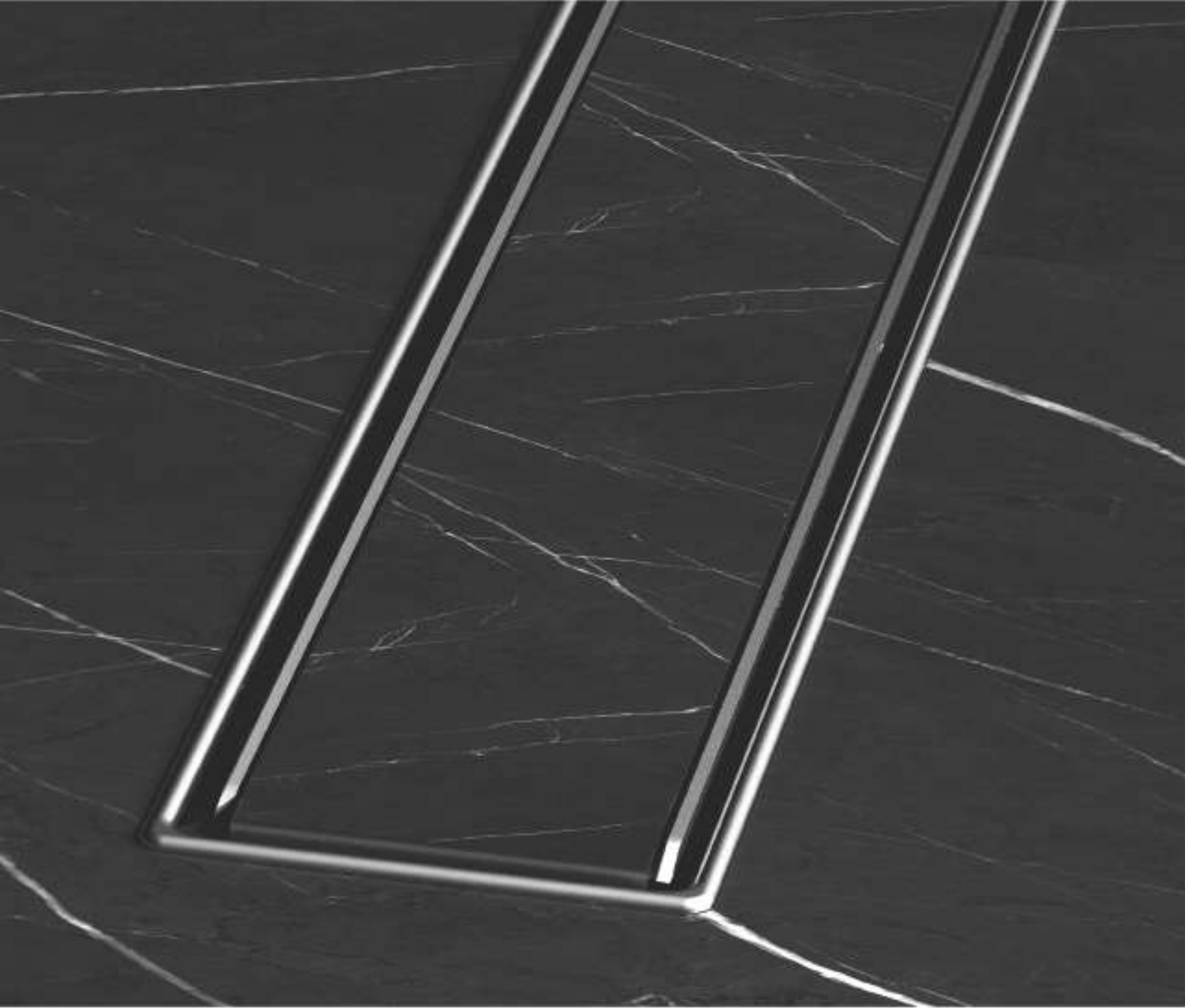

PH DESIGN

Premium serisi ile duř alanlarına modern , estetik ve kullanıřlı çözümler sunuyor. Hemzemin uygulama karo ile bütünleřerek engelsiz banyolar yaratıyor. Yeni teknolojiyi kullanarak PATENTLİ CONTASIZ sistem ile sızdırmalıkta standartları yeniden belirleniyor.

Premium serisi ürünler;

-Yalıtım etekli kaynaksız yekpare gövde, řap yükseklięini için yükseklik ayar seti, farklı montaj yükseklikleri ve drenaj kapasiteleri ile projelere uygun alternatif mekanik çözümler sunan, 360 derece dönebilen yüksek drenaj kapasiteli koku fermatürlü S sifon, saç tutucu, 20 cm geniřlięinde bütümlü bant, uygulama sonrası oluşabilecek kot farklılıklarını önleyen yükseklik ayar setini uygulama kolaylıęı sağlayacak řekilde standardize ederek, tek parça ürün olarak birleřtiriyor ve kullanıcılara kolay montaj avantajı sunuyor.

EBAT Size	Mermer Marble	
30 cm	DP 030 01 02 S01	130 \$
40 cm	DP 040 01 02 S01	151 \$
50 cm	DP 050 01 02 S01	168 \$
60 cm	DP 060 01 02 S01	187 \$
70 cm	DP 070 01 02 S01	205 \$
80 cm	DP 080 01 02 S01	229 \$
90 cm	DP 090 01 02 S01	261 \$
120 cm	DP 120 01 02 S01	316 \$

Size uygun sifon tipini siparişiniz esnasında ürün koduna ekleyiniz.
Please add the siphon type to the product code in your order.

S01

h : 60 mm
Debi: 42 lt/dk - Flow: 42 lt/min
Kokusuz / Odor free



S02

h : 70 mm
Debi: 48 lt/dk - Flow: 48 lt/min
Kokusuz / Odor free



S03

h : 30/80 mm
Karat ø: 120mm - Care Drill Diameter ø: 120mm
Debi : 48 lt/dk - Flow: 48 lt/dk
Kokusuz / Odor free



S11

h : 60 mm
Debi: 42 lt/dk - Flow: 42 lt/min
Kokusuz / Odor free



S13

h : 60 mm
Karat ø: 110 mm - Care Drill Diameter ø: 110 mm
Debi: 48 lt/dk - Flow: 48 lt/min
Kokusuz / Odor free



S14

h : 80 mm
Debi : 60 lt/dk - Flow: 60 lt/dk
Kokusuz / Odor free



S15

h : 60 mm
Debi: 42 lt/dk - Flow: 42 lt/min
Kokusuz / Odor free



S16

h : 80 mm
Debi: 60 lt/dk - Flow: 60 lt/min
Kokusuz / Odor free



S50/S95

Sifonsuz Direkt Bağlantı
(Direct Connection Without Siphon)
S50 for 2 inc (50 mm)
S95 for 4 inc (90 mm-110 mm)



Seramik Uyumlu Kapak (Çift Yönlü Kullanılabilir Kapak)

Paslanmaz çelik kapak aynı zamanda ters çevrilerek, içine kaplama malzemeniz uygulanır. Banyonuzda bütünsel şıklık sağlar.

Ceramic Compatible Cover (Reversible Cover)

The stainless steel cover is also reversed and your coating material is applied inside. It provides holistic elegance in your bathroom.

Dünya da ilk ve TEK! Patentli contasız paslanmaz çelik gövde ve sifon bağlantısı ile %100 sızdırmazlık garantisi.

First and ONLY in the world! 100% impermeability guarantee with patented non-gasket stainless steel body and siphon connection.

 360° base rotation	 60 mm	 Ø50 output	 304 stainless steel
		 + easy to clean	 51l/min
		 odor prevent system	 easy assembling

PREMIUM
ELEGANT

DRAINLINE

PH
Dizayn

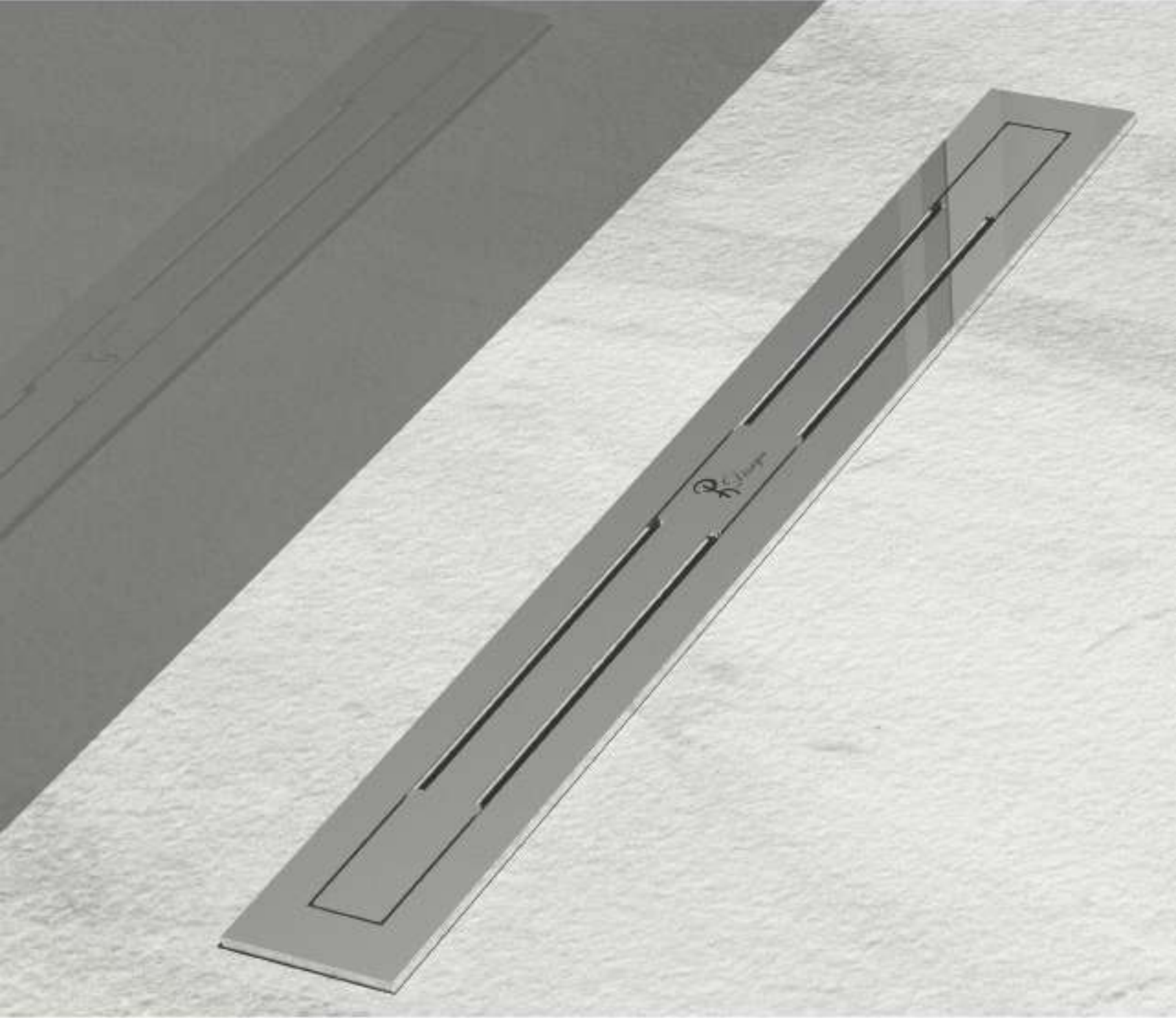

PH DESIGN

Premium serisi ile duř alanlarına modern , estetik ve kullanıřlı çözümler sunuyor. Hemzemin uygulama karo ile bütünleřerek engelsiz banyolar yaratıyor. Yeni teknolojiyi kullanarak PATENTLİ CONTASIZ sistem ile sızdırmalıkta standartları yeniden belirleniyor.

Premium serisi ürünler;

-Yalıtım etekli kaynaksız yekpare gövde, řap yüksekliđini için yükseklik ayar seti, farklı montaj yükseklikleri ve drenaj kapasiteleri ile projelere uygun alternatif mekanik çözümler sunan, 360 derece dönebilen yüksek drenaj kapasiteli koku fermatürlü S sifon, saç tutucu, 20 cm genişliđinde bütül bant, uygulama sonrası oluşabilecek kot farklılıklarını önleyen yükseklik ayar setini uygulama

39 kolaylıđı sağlayacak şekilde standardize ederek, tek parça ürün olarak birleřtiriyor ve kullanıcılara kolay montaj avantajı sunuyor.

EBAT Size	Inox Satinox		Satine Altın Satin Gold		Satine Bakır Satin Bronze		Siyah Black	
40 cm	DP 040 01 07 S01	154 \$	DP 040 21 07 S01	251 \$	DP 040 31 07 S01	275 \$	DP 040 55 07 S01	251 \$
50 cm	DP 050 01 07 S01	172 \$	DP 050 21 07 S01	269 \$	DP 050 31 07 S01	293 \$	DP 050 55 07 S01	269 \$
60 cm	DP 060 01 07 S01	191 \$	DP 060 21 07 S01	288 \$	DP 060 31 07 S01	312 \$	DP 060 55 07 S01	288 \$
70 cm	DP 070 01 07 S01	220 \$	DP 070 21 07 S01	331 \$	DP 070 31 07 S01	359 \$	DP 070 55 07 S01	331 \$
80 cm	DP 080 01 07 S01	234 \$	DP 080 21 07 S01	365 \$	DP 080 31 07 S01	398 \$	DP 080 55 07 S01	365 \$
90 cm	DP 090 01 07 S01	269 \$	DP 090 21 07 S01	419 \$	DP 090 31 07 S01	458 \$	DP 090 55 07 S01	419 \$
120 cm	DP 120 01 07 S01	323 \$	DP 120 21 07 S01	517 \$	DP 120 31 07 S01	565 \$	DP 120 55 07 S01	517 \$

EBAT Size	Inox Ayna Inox Mirror		Altın Ayna Gold Mirror		Bakır Ayna Bronze Mirror	
40 cm	DP 040 00 07 S01	185 \$	DP 040 20 07 S01	251 \$	DP 040 30 07 S01	275 \$
50 cm	DP 050 00 07 S01	199 \$	DP 050 20 07 S01	269 \$	DP 050 30 07 S01	293 \$
60 cm	DP 060 00 07 S01	221 \$	DP 060 20 07 S01	288 \$	DP 060 30 07 S01	312 \$
70 cm	DP 070 00 07 S01	254 \$	DP 070 20 07 S01	331 \$	DP 070 30 07 S01	359 \$
80 cm	DP 080 00 07 S01	256 \$	DP 080 20 07 S01	365 \$	DP 080 30 07 S01	398 \$
90 cm	DP 090 00 07 S01	294 \$	DP 090 20 07 S01	419 \$	DP 090 30 07 S01	458 \$
120 cm	DP 120 00 07 S01	366 \$	DP 120 20 07 S01	517 \$	DP 120 30 07 S01	565 \$



Size uygun sifon tipini siparişiniz esnasında ürün koduna ekleyiniz.
Please add the siphon type to the product code in your order.

S01

h : 60 mm
Debi: 42 lt/dk - Flow: 42 lt/min
Kokusuz / Odor free



S02

h : 70 mm
Debi: 48 lt/dk - Flow: 48 lt/min
Kokusuz / Odor free



S03

h : 30/80 mm
Karat ø: 120mm - Care Drill Diameter ø: 120mm
Debi : 48 lt/dk - Flow: 48 lt/dk
Kokusuz / Odor free



S11

h : 60 mm
Debi: 42 lt/dk - Flow: 42 lt/min
Kokusuz / Odor free



S13

h : 60 mm
Karat ø: 110 mm - Care Drill Diameter ø: 110 mm
Debi: 48 lt/dk - Flow: 48 lt/min
Kokusuz / Odor free



S14

h : 80 mm
Debi : 60 lt/dk - Flow: 60 lt/dk
Kokusuz / Odor free



S15

h : 60 mm
Debi: 42 lt/dk - Flow: 42 lt/min
Kokusuz / Odor free



S16

h : 80 mm
Debi: 60 lt/dk - Flow: 60 lt/min
Kokusuz / Odor free



S50/S95

Sifonsuz Direkt Bağlantı
(Direct Connection Without Siphon)
S50 for 2 inc (50 mm)
S95 for 4 inc (90 mm-110 mm)



PREMIUM
QDRAIN

DRAINLINE

PH Dizayn



PH DESIGN

Premium serisi ile duř alanlarına modern , estetik ve kullanıřlı çözümler sunuyor. Hemzemin uygulama karo ile bütünleřerek engelsiz banyolar yaratıyor. Yeni teknolojiyi kullanarak PATENTLİ CONTASIZ sistem ile sızdırmalıkta standartları yeniden belirleniyor.

Premium serisi ürünler;

-Yalıtım etekli kaynaksız yekpare gövde , řap yüksekliđini için yükseklik ayar seti, farklı montaj yükseklikleri ve drenaj kapasiteleri ile projelere uygun alternatif mekanik çözümler sunan, 360 derece dönebilen yüksek drenaj kapasiteli koku fermatürlü S sifon, saç tutucu, 20 cm genişliğinde bütül bant, uygulama sonrası oluşabilecek kot farklılıklarını önleyen yükseklik ayar setini uygulama kolaylıđı sağlayacak řekilde standardize ederek, tek parça ürün olarak birleřtiriyor ve kullanıcılara kolay montaj avantajı sunuyor.

EBAT Size	Inox Satinox		Satine Altın Satin Gold		Satine Bakır Satin Bronze		Siyah Black	
40 cm	DP 040 01 08 S01	154 \$	DP 040 21 08 S01	251 \$	DP 040 31 08 S01	275 \$	DP 040 55 08 S01	251 \$
50 cm	DP 050 01 08 S01	172 \$	DP 050 21 08 S01	269 \$	DP 050 31 08 S01	293 \$	DP 050 55 08 S01	269 \$
60 cm	DP 060 01 08 S01	191 \$	DP 060 21 08 S01	288 \$	DP 060 31 08 S01	312 \$	DP 060 55 08 S01	288 \$
70 cm	DP 070 01 08 S01	220 \$	DP 070 21 08 S01	331 \$	DP 070 31 08 S01	359 \$	DP 070 55 08 S01	331 \$
80 cm	DP 080 01 08 S01	234 \$	DP 080 21 08 S01	365 \$	DP 080 31 08 S01	398 \$	DP 080 55 08 S01	365 \$
90 cm	DP 090 01 08 S01	269 \$	DP 090 21 08 S01	419 \$	DP 090 31 08 S01	458 \$	DP 090 55 08 S01	419 \$
120 cm	DP 120 01 08 S01	323 \$	DP 120 21 08 S01	517 \$	DP 120 31 08 S01	565 \$	DP 120 55 08 S01	517 \$

EBAT Size	Inox Ayna Inox Mirror		Altın Ayna Gold Mirror		Bakır Ayna Bronze Mirror	
40 cm	DP 040 00 08 S01	185 \$	DP 040 20 08 S01	251 \$	DP 040 30 08 S01	275 \$
50 cm	DP 050 00 08 S01	199 \$	DP 050 20 08 S01	269 \$	DP 050 30 08 S01	293 \$
60 cm	DP 060 00 08 S01	221 \$	DP 060 20 08 S01	288 \$	DP 060 30 08 S01	312 \$
70 cm	DP 070 00 08 S01	254 \$	DP 070 20 08 S01	331 \$	DP 070 30 08 S01	359 \$
80 cm	DP 080 00 08 S01	256 \$	DP 080 20 08 S01	365 \$	DP 080 30 08 S01	398 \$
90 cm	DP 090 00 08 S01	294 \$	DP 090 20 08 S01	419 \$	DP 090 30 08 S01	458 \$
120 cm	DP 120 00 08 S01	366 \$	DP 120 20 08 S01	517 \$	DP 120 30 08 S01	565 \$



Size uygun sifon tipini siparişiniz esnasında ürün koduna ekleyiniz.
Please add the siphon type to the product code in your order.

S01

h : 60 mm
Debi: 42 lt/dk - Flow: 42 lt/min
Kokusuz / Odor free



S02

h : 70 mm
Debi: 48 lt/dk - Flow: 48 lt/min
Kokusuz / Odor free



S03

h : 30/80 mm
Karat ø: 120mm - Care Drill Diameter ø: 120mm
Debi : 48 lt/dk - Flow: 48 lt/dk
Kokusuz / Odor free



S11

h : 60 mm
Debi: 42 lt/dk - Flow: 42 lt/min
Kokusuz / Odor free



S13

h : 60 mm
Karat ø: 110 mm - Care Drill Diameter ø: 110 mm
Debi: 48 lt/dk - Flow: 48 lt/min
Kokusuz / Odor free



S14

h : 80 mm
Debi : 60 lt/dk - Flow: 60 lt/dk
Kokusuz / Odor free



S15

h : 60 mm
Debi: 42 lt/dk - Flow: 42 lt/min
Kokusuz / Odor free



S16

h : 80 mm
Debi: 60 lt/dk - Flow: 60 lt/min
Kokusuz / Odor free



S50/S95

Sifonsuz Direkt Bağlantı
(Direct Connection Without Siphon)
S50 for 2 inc (50 mm)
S95 for 4 inc (90 mm-110 mm)



PREMIUM
TRENDY

DRAINLINE

PH Dizayn

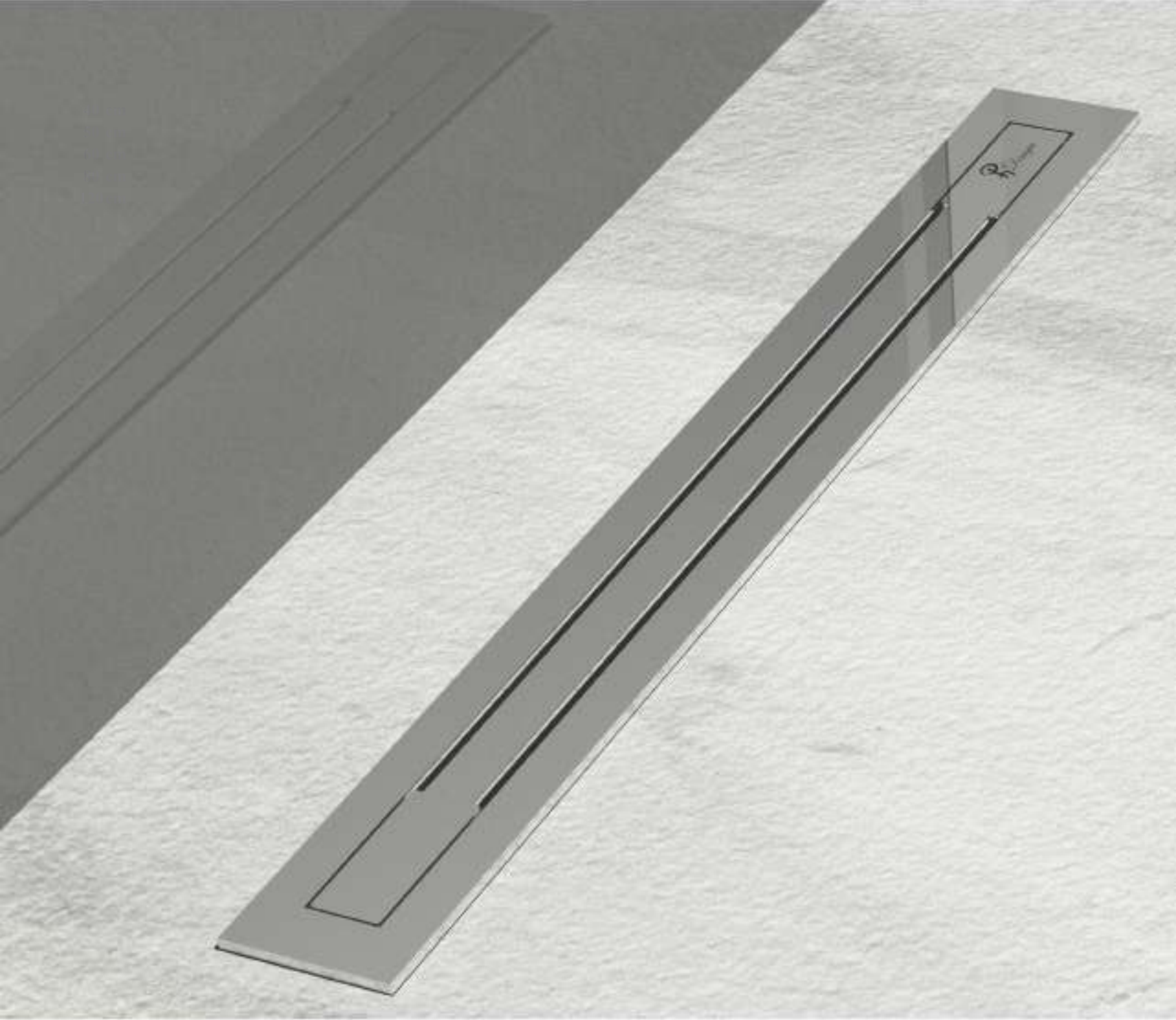

PH DESIGN

Premium serisi ile duř alanlarına modern , estetik ve kullanıřlı çözümler sunuyor. Hemzemin uygulama karo ile bütünleřerek engelsiz banyolar yaratıyor. Yeni teknolojiyi kullanarak PATENTLİ CONTASIZ sistem ile sızdırmalıkta standartları yeniden belirleniyor.

Premium serisi ürünler;

-Yalıtım etekli kaynaksız yekpare gövde, řap yüksekliđini için yükseklik ayar seti, farklı montaj yükseklikleri ve drenaj kapasiteleri ile projelere uygun alternatif mekanik çözümler sunan, 360 derece dönebilen yüksek drenaj kapasiteli koku fermatürlü S sifon, saç tutucu, 20 cm genişliđinde bütöl bant, uygulama sonrası oluşabilecek kot farklılıklarını önleyen yükseklik ayar setini uygulama

EBAT Size	Inox Satinox		Satine Altın Satin Gold		Satine Bakır Satin Bronze		Siyah Black	
40 cm	DP 040 01 09 S01	154 \$	DP 040 21 09 S01	251 \$	DP 040 31 09 S01	275 \$	DP 040 55 09 S01	251 \$
50 cm	DP 050 01 09 S01	172 \$	DP 050 21 09 S01	269 \$	DP 050 31 09 S01	293 \$	DP 050 55 09 S01	269 \$
60 cm	DP 060 01 09 S01	191 \$	DP 060 21 09 S01	288 \$	DP 060 31 09 S01	312 \$	DP 060 55 09 S01	288 \$
70 cm	DP 070 01 09 S01	220 \$	DP 070 21 09 S01	331 \$	DP 070 31 09 S01	359 \$	DP 070 55 09 S01	331 \$
80 cm	DP 080 01 09 S01	234 \$	DP 080 21 09 S01	365 \$	DP 080 31 09 S01	398 \$	DP 080 55 09 S01	365 \$
90 cm	DP 090 01 09 S01	269 \$	DP 090 21 09 S01	419 \$	DP 090 31 09 S01	458 \$	DP 090 55 09 S01	419 \$
120 cm	DP 120 01 09 S01	323 \$	DP 120 21 09 S01	517 \$	DP 120 31 09 S01	565 \$	DP 120 55 09 S01	517 \$

EBAT Size	Inox Ayna Inox Mirror		Altın Ayna Gold Mirror		Bakır Ayna Bronze Mirror	
40 cm	DP 040 00 09 S01	185 \$	DP 040 20 09 S01	251 \$	DP 040 30 09 S01	275 \$
50 cm	DP 050 00 09 S01	199 \$	DP 050 20 09 S01	269 \$	DP 050 30 09 S01	293 \$
60 cm	DP 060 00 09 S01	221 \$	DP 060 20 09 S01	288 \$	DP 060 30 09 S01	312 \$
70 cm	DP 070 00 09 S01	254 \$	DP 070 20 09 S01	331 \$	DP 070 30 09 S01	359 \$
80 cm	DP 080 00 09 S01	256 \$	DP 080 20 09 S01	365 \$	DP 080 30 09 S01	398 \$
90 cm	DP 090 00 09 S01	294 \$	DP 090 20 09 S01	419 \$	DP 090 30 09 S01	458 \$
120 cm	DP 120 00 09 S01	366 \$	DP 120 20 09 S01	517 \$	DP 120 30 09 S01	565 \$



Size uygun sifon tipini siparişiniz esnasında ürün koduna ekleyiniz.
Please add the siphon type to the product code in your order.

S01

h : 60 mm
Debi: 42 lt/dk - Flow: 42 lt/min
Kokusuz / Odor free



S02

h : 70 mm
Debi: 48 lt/dk - Flow: 48 lt/min
Kokusuz / Odor free



S03

h : 30/80 mm
Karat ø: 120mm - Care Drill Diameter ø: 120mm
Debi : 48 lt/dk - Flow: 48 lt/dk
Kokusuz / Odor free



S11

h : 60 mm
Debi: 42 lt/dk - Flow: 42 lt/min
Kokusuz / Odor free



S13

h : 60 mm
Karat ø: 110 mm - Care Drill Diameter ø: 110 mm
Debi: 48 lt/dk - Flow: 48 lt/min
Kokusuz / Odor free



S14

h : 80 mm
Debi : 60 lt/dk - Flow: 60 lt/dk
Kokusuz / Odor free



S15

h : 60 mm
Debi: 42 lt/dk - Flow: 42 lt/min
Kokusuz / Odor free



S16

h : 80 mm
Debi: 60 lt/dk - Flow: 60 lt/min
Kokusuz / Odor free



S50/S95

Sifonsuz Direkt Bağlantı
(Direct Connection Without Siphon)
S50 for 2 inc (50 mm)
S95 for 4 inc (90 mm-110 mm)



PREMIUM
GREEK

DRAINLINE

PH
Dizayn

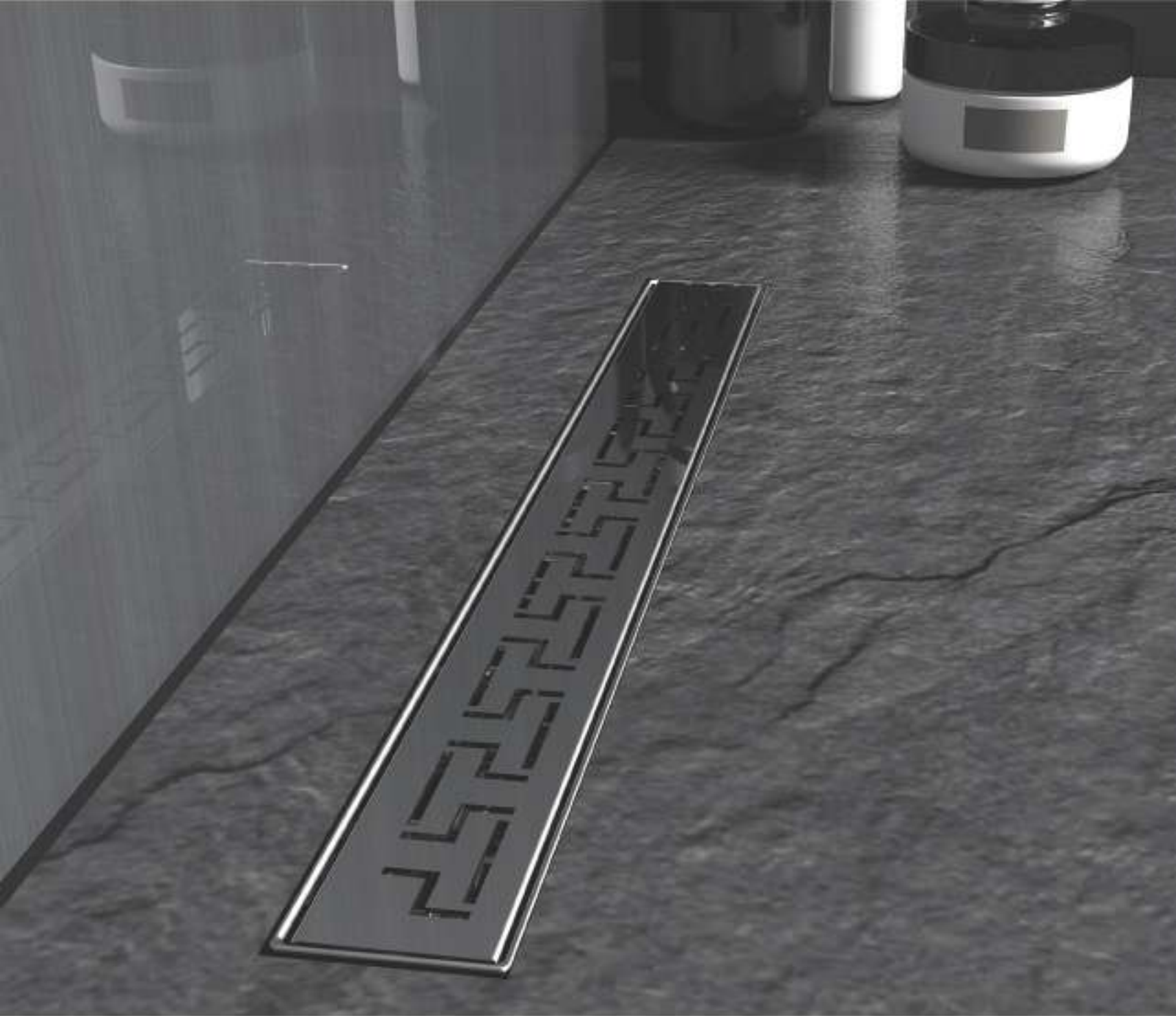

PH DESIGN

Premium serisi ile duř alanlarına modern , estetik ve kullanıřlı çözümler sunuyor. Hemzemin uygulama karo ile bütünleřerek engelsiz banyolar yaratıyor. Yeni teknolojiyi kullanarak PATENTLİ CONTASIZ sistem ile sızdırmalıkta standartları yeniden belirleniyor.

Premium serisi ürünler;

-Yalıtım etekli kaynaksız yekpare gövde, řap yüksekliđini için yükseklik ayar seti, farklı montaj yükseklikleri ve drenaj kapasiteleri ile projelere uygun alternatif mekanik çözümler sunan, 360 derece dönebilen yüksek drenaj kapasiteli koku fermatürlü S sifon, saç tutucu, 20 cm genişliğinde bütül bant, uygulama sonrası oluşabilecek kot farklılıklarını önleyen yükseklik ayar setini uygulama kolaylığı sağlayacak şekilde standardize ederek, tek parça ürün olarak birleřtiriyor ve kullanıcılara kolay montaj avantajı sunuyor.

EBAT Size	Inox Satinox	Satine Altın Satin Gold	Satine Bakır Satin Bronze	Siyah Black
30 cm	DP 030 01 01 S01	DP 030 21 01 S01	DP 030 31 01 S01	DP 030 55 01 S01
40 cm	DP 040 01 01 S01	DP 040 21 01 S01	DP 040 31 01 S01	DP 040 55 01 S01
50 cm	DP 050 01 01 S01	DP 050 21 01 S01	DP 050 31 01 S01	DP 050 55 01 S01
60 cm	DP 060 01 01 S01	DP 060 21 01 S01	DP 060 31 01 S01	DP 060 55 01 S01
70 cm	DP 070 01 01 S01	DP 070 21 01 S01	DP 070 31 01 S01	DP 070 55 01 S01
80 cm	DP 080 01 01 S01	DP 080 21 01 S01	DP 080 31 01 S01	DP 080 55 01 S01
90 cm	DP 090 01 01 S01	DP 090 21 01 S01	DP 090 31 01 S01	DP 090 55 01 S01
120 cm	DP 120 01 01 S01	DP 120 21 01 S01	DP 120 31 01 S01	DP 120 55 01 S01

EBAT Size	Inox Ayna Inox Mirror	Altın Ayna Gold Mirror	Bakır Ayna Bronze Mirror
30 cm	DP 030 00 01 S01	DP 030 20 01 S01	DP 030 30 01 S01
40 cm	DP 040 00 01 S01	DP 040 20 01 S01	DP 040 30 01 S01
50 cm	DP 050 00 01 S01	DP 050 20 01 S01	DP 050 30 01 S01
60 cm	DP 060 00 01 S01	DP 060 20 01 S01	DP 060 30 01 S01
70 cm	DP 070 00 01 S01	DP 070 20 01 S01	DP 070 30 01 S01
80 cm	DP 080 00 01 S01	DP 080 20 01 S01	DP 080 30 01 S01
90 cm	DP 090 00 01 S01	DP 090 20 01 S01	DP 090 30 01 S01
120 cm	DP 120 00 01 S01	DP 120 20 01 S01	DP 120 30 01 S01



Size uygun sifon tipini siparişiniz esnasında ürün koduna ekleyiniz.
Please add the siphon type to the product code in your order.

S01

h : 60 mm
Debi: 42 lt/dk - Flow: 42 lt/min
Kokusuz / Odor free



S02

h : 70 mm
Debi: 48 lt/dk - Flow: 48 lt/min
Kokusuz / Odor free



S03

h : 30/80 mm
Karat ø: 120mm - Care Drill Diameter ø: 120mm
Debi : 48 lt/dk - Flow: 48 lt/dk
Kokusuz / Odor free



S11

h : 60 mm
Debi: 42 lt/dk - Flow: 42 lt/min
Kokusuz / Odor free



S13

h : 60 mm
Karat ø: 110 mm - Care Drill Diameter ø: 110 mm
Debi: 48 lt/dk - Flow: 48 lt/min
Kokusuz / Odor free



S14

h : 80 mm
Debi : 60 lt/dk - Flow: 60 lt/dk
Kokusuz / Odor free



S15

h : 60 mm
Debi: 42 lt/dk - Flow: 42 lt/min
Kokusuz / Odor free



S16

h : 80 mm
Debi: 60 lt/dk - Flow: 60 lt/min
Kokusuz / Odor free



S50/S95

Sifonsuz Direkt Bağlantı
(Direct Connection Without Siphon)
S50 for 2 inc (50 mm)
S95 for 4 inc (90 mm-110 mm)



PREMIUM
CIRCLE

DRAINLINE

PH
Dizayn

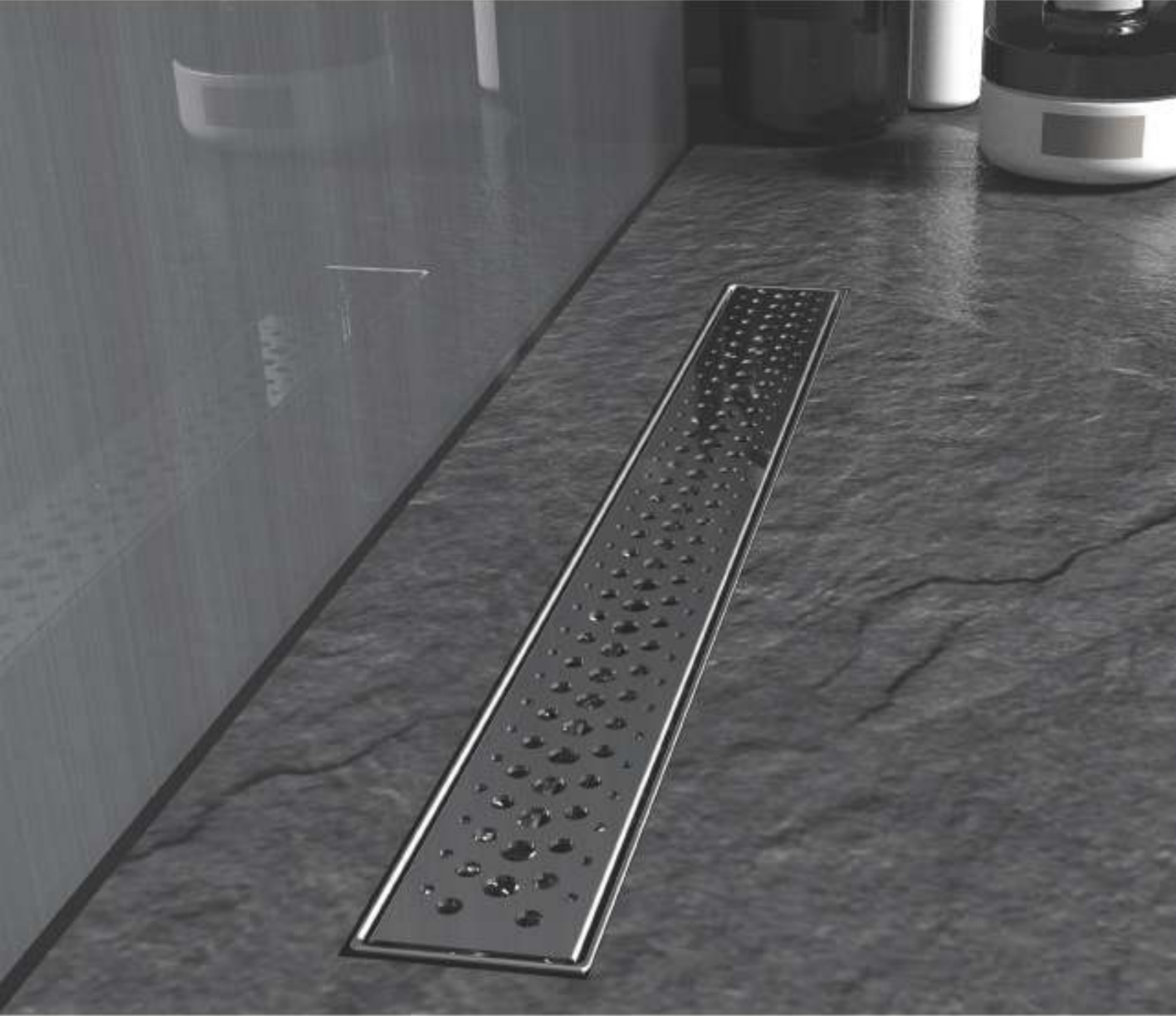

PH DESIGN

Premium serisi ile duř alanlarına modern , estetik ve kullanıřlı çözümler sunuyor. Hemzemin uygulama karo ile bütünleřerek engelsiz banyolar yaratıyor. Yeni teknolojiyi kullanarak PATENTLİ CONTASIZ sistem ile sızdırmalıktaki standartları yeniden belirliyor.

Premium serisi ürünler;

-Yalıtım etekli kaynaksız yekpare gövde, řap yüksekliđini için yükseklik ayar seti, farklı montaj yükseklikleri ve drenaj kapasiteleri ile projelere uygun alternatif mekanik çözümler sunan, 360 derece dönebilen yüksek drenaj kapasiteli koku fermatürlü S sifon, saç tutucu, 20 cm genişliğinde bütül bant, uygulama sonrası oluşabilecek kot farklılıklarını önleyen yükseklik ayar setini uygulama kolaylıđı sağlayacak şekilde standardize ederek, tek parça ürün olarak birleřtiriyor ve kullanıcılara kolay montaj avantajı sunuyor.

EBAT Size	Inox Satinox		Satine Altın Satin Gold		Satine Bakır Satin Bronze		Siyah Black	
30 cm	DP 030 01 03 S01	122 \$	DP 030 21 03 S01	219 \$	DP 030 31 03 S01	243 \$	DP 030 55 03 S01	219 \$
40 cm	DP 040 01 03 S01	142 \$	DP 040 21 03 S01	239 \$	DP 040 31 03 S01	263 \$	DP 040 55 03 S01	239 \$
50 cm	DP 050 01 03 S01	156 \$	DP 050 21 03 S01	253 \$	DP 050 31 03 S01	277 \$	DP 050 55 03 S01	253 \$
60 cm	DP 060 01 03 S01	183 \$	DP 060 21 03 S01	280 \$	DP 060 31 03 S01	304 \$	DP 060 55 03 S01	280 \$
70 cm	DP 070 01 03 S01	200 \$	DP 070 21 03 S01	297 \$	DP 070 31 03 S01	321 \$	DP 070 55 03 S01	297 \$
80 cm	DP 080 01 03 S01	219 \$	DP 080 21 03 S01	350 \$	DP 080 31 03 S01	383 \$	DP 080 55 03 S01	350 \$
90 cm	DP 090 01 03 S01	249 \$	DP 090 21 03 S01	443 \$	DP 090 31 03 S01	491 \$	DP 090 55 03 S01	443 \$
120 cm	DP 120 01 03 S01	311 \$	DP 120 21 03 S01	505 \$	DP 120 31 03 S01	553 \$	DP 120 55 03 S01	505 \$

EBAT Size	Inox Ayna Inox Mirror		Altın Ayna Gold Mirror		Bakır Ayna Bronze Mirror	
30 cm	DP 030 00 03 S01	141 \$	DP 030 20 03 S01	219 \$	DP 030 30 03 S01	243 \$
40 cm	DP 040 00 03 S01	153 \$	DP 040 20 03 S01	239 \$	DP 040 30 03 S01	263 \$
50 cm	DP 050 00 03 S01	169 \$	DP 050 20 03 S01	253 \$	DP 050 30 03 S01	277 \$
60 cm	DP 060 00 03 S01	196 \$	DP 060 20 03 S01	280 \$	DP 060 30 03 S01	304 \$
70 cm	DP 070 00 03 S01	223 \$	DP 070 20 03 S01	297 \$	DP 070 30 03 S01	321 \$
80 cm	DP 080 00 03 S01	233 \$	DP 080 20 03 S01	350 \$	DP 080 30 03 S01	383 \$
90 cm	DP 090 00 03 S01	275 \$	DP 090 20 03 S01	443 \$	DP 090 30 03 S01	491 \$
120 cm	DP 120 00 03 S01	338 \$	DP 120 20 03 S01	505 \$	DP 120 30 03 S01	553 \$



Size uygun sifon tipini siparişiniz esnasında ürün koduna ekleyiniz.
Please add the siphon type to the product code in your order.

S01

h : 60 mm
Debi: 42 lt/dk - Flow: 42 lt/min
Kokusuz / Odor free



S02

h : 70 mm
Debi: 48 lt/dk - Flow: 48 lt/min
Kokusuz / Odor free



S03

h : 30/80 mm
Karat ø: 120mm - Care Drill Diameter ø: 120mm
Debi : 48 lt/dk - Flow: 48 lt/dk
Kokusuz / Odor free



S11

h : 60 mm
Debi: 42 lt/dk - Flow: 42 lt/min
Kokusuz / Odor free



S13

h : 60 mm
Karat ø: 110 mm - Care Drill Diameter ø: 110 mm
Debi: 48 lt/dk - Flow: 48 lt/min
Kokusuz / Odor free



S14

h : 80 mm
Debi : 60 lt/dk - Flow: 60 lt/dk
Kokusuz / Odor free



S15

h : 60 mm
Debi: 42 lt/dk - Flow: 42 lt/min
Kokusuz / Odor free



S16

h : 80 mm
Debi: 60 lt/dk - Flow: 60 lt/min
Kokusuz / Odor free



S50/S95

Sifonsuz Direkt Bağlantı
(Direct Connection Without Siphon)
S50 for 2 inc (50 mm)
S95 for 4 inc (90 mm-110 mm)



PREMIUM
SQUARE

DRAINLINE

PH
Dizayn

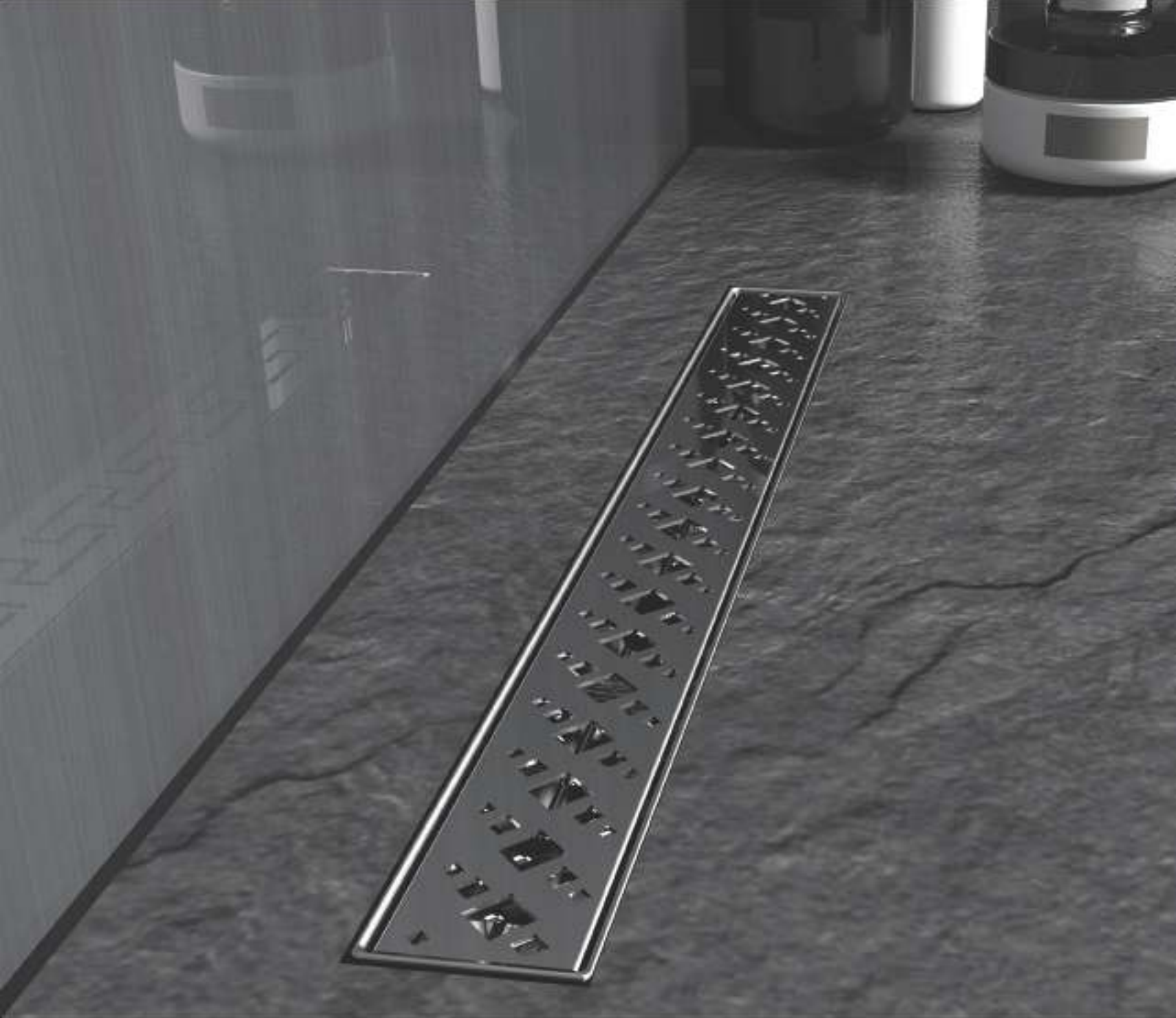

PH DESIGN

Premium serisi ile duř alanlarına modern , estetik ve kullanıřlı çözümler sunuyor. Hemzemin uygulama karo ile bütünleřerek engelsiz banyolar yaratıyor. Yeni teknolojiyi kullanarak PATENTLİ CONTASIZ sistem ile sızdırmalıkta standartları yeniden belirleniyor.

Premium serisi ürünler;

-Yalıtım etekli kaynaksız yekpare gövde, řap yükseklięini için yükseklik ayar seti, farklı montaj yükseklikleri ve drenaj kapasiteleri ile projelere uygun alternatif mekanik çözümler sunan, 360 derece dönebilen yüksek drenaj kapasiteli koku fermatürlü S sifon, saç tutucu, 20 cm genişliğinde bütül bant, uygulama sonrası oluşabilecek kot farklılıklarını önleyen yükseklik ayar setini uygulama

EBAT Size	Inox Satinox		Satine Altın Satin Gold		Satine Bakır Satin Bronze		Siyah Black	
30 cm	DP 030 01 04 S01	122 \$	DP 030 21 04 S01	219 \$	DP 030 31 04 S01	243 \$	DP 030 55 04 S01	219 \$
40 cm	DP 040 01 04 S01	142 \$	DP 040 21 04 S01	239 \$	DP 040 31 04 S01	263 \$	DP 040 55 04 S01	239 \$
50 cm	DP 050 01 04 S01	156 \$	DP 050 21 04 S01	253 \$	DP 050 31 04 S01	277 \$	DP 050 55 04 S01	253 \$
60 cm	DP 060 01 04 S01	183 \$	DP 060 21 04 S01	280 \$	DP 060 31 04 S01	304 \$	DP 060 55 04 S01	280 \$
70 cm	DP 070 01 04 S01	200 \$	DP 070 21 04 S01	297 \$	DP 070 31 04 S01	321 \$	DP 070 55 04 S01	297 \$
80 cm	DP 080 01 04 S01	219 \$	DP 080 21 04 S01	350 \$	DP 080 31 04 S01	383 \$	DP 080 55 04 S01	350 \$
90 cm	DP 090 01 04 S01	249 \$	DP 090 21 04 S01	443 \$	DP 090 31 04 S01	491 \$	DP 090 55 04 S01	443 \$
120 cm	DP 120 01 04 S01	311 \$	DP 120 21 04 S01	505 \$	DP 120 31 04 S01	553 \$	DP 120 55 04 S01	505 \$

EBAT Size	Inox Ayna Inox Mirror		Altın Ayna Gold Mirror		Bakır Ayna Bronze Mirror	
30 cm	DP 030 00 04 S01	141 \$	DP 030 20 04 S01	219 \$	DP 030 30 04 S01	243 \$
40 cm	DP 040 00 04 S01	153 \$	DP 040 20 04 S01	239 \$	DP 040 30 04 S01	263 \$
50 cm	DP 050 00 04 S01	169 \$	DP 050 20 04 S01	253 \$	DP 050 30 04 S01	277 \$
60 cm	DP 060 00 04 S01	196 \$	DP 060 20 04 S01	280 \$	DP 060 30 04 S01	304 \$
70 cm	DP 070 00 04 S01	223 \$	DP 070 20 04 S01	297 \$	DP 070 30 04 S01	321 \$
80 cm	DP 080 00 04 S01	233 \$	DP 080 20 04 S01	350 \$	DP 080 30 04 S01	383 \$
90 cm	DP 090 00 04 S01	275 \$	DP 090 20 04 S01	443 \$	DP 090 30 04 S01	491 \$
120 cm	DP 120 00 04 S01	338 \$	DP 120 20 04 S01	505 \$	DP 120 30 04 S01	553 \$



Size uygun sifon tipini siparişiniz esnasında ürün koduna ekleyiniz.
Please add the siphon type to the product code in your order.

S01

h : 60 mm
Debi: 42 lt/dk - Flow: 42 lt/min
Kokusuz / Odor free



S02

h : 70 mm
Debi: 48 lt/dk - Flow: 48 lt/min
Kokusuz / Odor free



S03

h : 30/80 mm
Karat ø: 120mm - Care Drill Diameter ø: 120mm
Debi : 48 lt/dk - Flow: 48 lt/dk
Kokusuz / Odor free



S11

h : 60 mm
Debi: 42 lt/dk - Flow: 42 lt/min
Kokusuz / Odor free



S13

h : 60 mm
Karat ø: 110 mm - Care Drill Diameter ø: 110 mm
Debi: 48 lt/dk - Flow: 48 lt/min
Kokusuz / Odor free



S14

h : 80 mm
Debi : 60 lt/dk - Flow: 60 lt/dk
Kokusuz / Odor free



S15

h : 60 mm
Debi: 42 lt/dk - Flow: 42 lt/min
Kokusuz / Odor free



S16

h : 80 mm
Debi: 60 lt/dk - Flow: 60 lt/min
Kokusuz / Odor free



S50/S95

Sifonsuz Direkt Bağlantı
(Direct Connection Without Siphon)
S50 for 2 inc (50 mm)
S95 for 4 inc (90 mm-110 mm)



PREMIUM
GEOX

DRAINLINE

PH
Dizayn

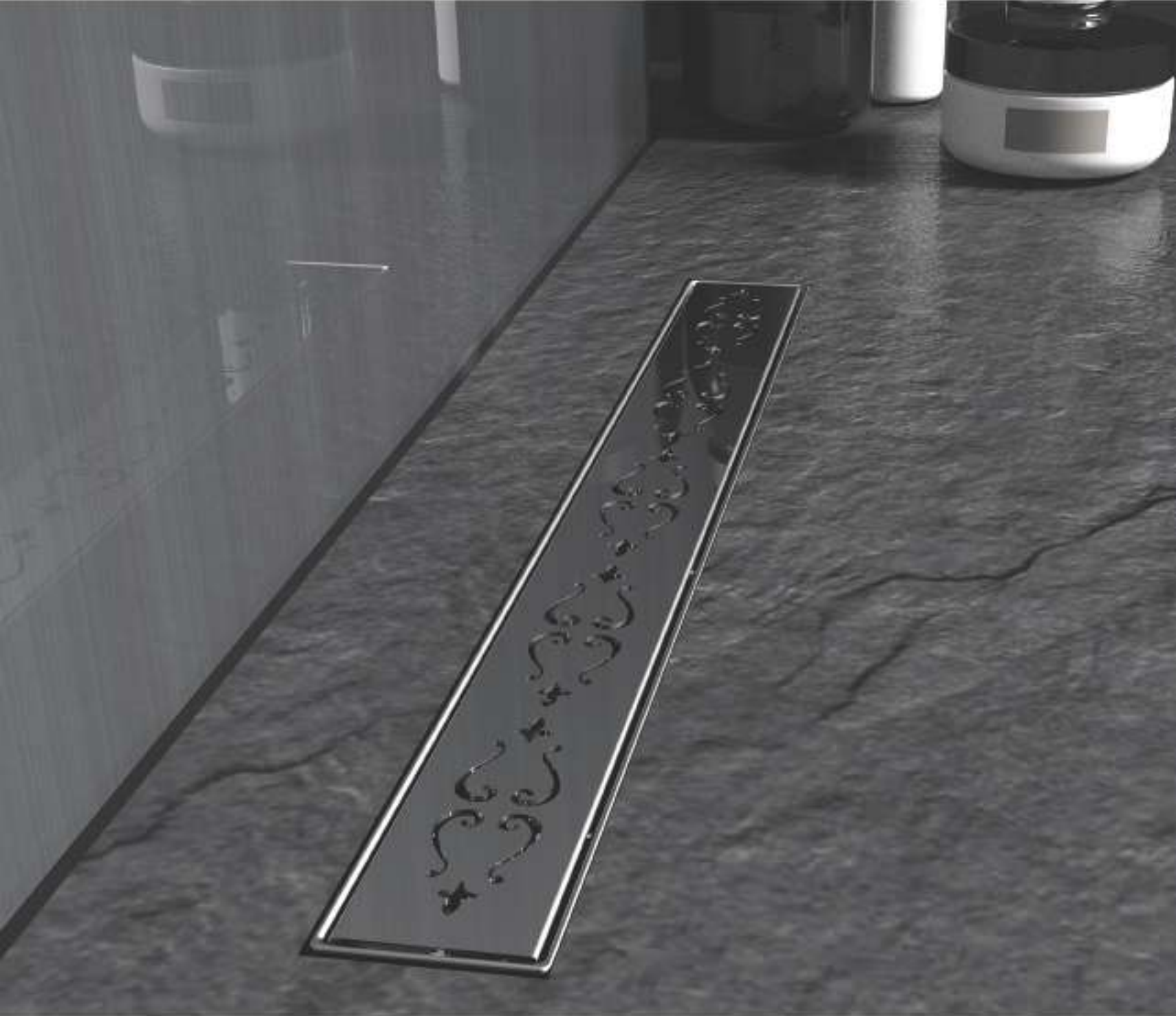

PH DESIGN

Premium serisi ile duř alanlarına modern , estetik ve kullanıřlı çözümler sunuyor. Hemzemin uygulama karo ile bütünleřerek engelsiz banyolar yaratıyor. Yeni teknolojiyi kullanarak PATENTLİ CONTASIZ sistem ile sızdırmalıkta standartları yeniden belirleniyor.

Premium serisi ürünler;

-Yalıtım etekli kaynaksız yekpare gövde, řap yüksekliđini için yükseklik ayar seti, farklı montaj yükseklikleri ve drenaj kapasiteleri ile projelere uygun alternatif mekanik çözümler sunan, 360 derece dönebilen yüksek drenaj kapasiteli koku fermatürlü S sifon, saç tutucu, 20 cm genişliğinde bütül bant, uygulama sonrası oluşabilecek kot farklılıklarını önleyen yükseklik ayar setini uygulama

51 kolaylıđı sağlayacak şekilde standardize ederek, tek parça ürün olarak birleřtiriyor ve kullanıcılara kolay montaj avantajı sunuyor.

EBAT Size	Inox Satinox		Satine Altın Satin Gold		Satine Bakır Satin Bronze		Siyah Black	
30 cm	DP 030 01 05 S01	122 \$	DP 030 21 05 S01	219 \$	DP 030 31 05 S01	243 \$	DP 030 55 05 S01	219 \$
40 cm	DP 040 01 05 S01	142 \$	DP 040 21 05 S01	239 \$	DP 040 31 05 S01	263 \$	DP 040 55 05 S01	239 \$
50 cm	DP 050 01 05 S01	156 \$	DP 050 21 05 S01	253 \$	DP 050 31 05 S01	277 \$	DP 050 55 05 S01	253 \$
60 cm	DP 060 01 05 S01	183 \$	DP 060 21 05 S01	280 \$	DP 060 31 05 S01	304 \$	DP 060 55 05 S01	280 \$
70 cm	DP 070 01 05 S01	200 \$	DP 070 21 05 S01	297 \$	DP 070 31 05 S01	321 \$	DP 070 55 05 S01	297 \$
80 cm	DP 080 01 05 S01	219 \$	DP 080 21 05 S01	350 \$	DP 080 31 05 S01	383 \$	DP 080 55 05 S01	350 \$
90 cm	DP 090 01 05 S01	249 \$	DP 090 21 05 S01	443 \$	DP 090 31 05 S01	491 \$	DP 090 55 05 S01	443 \$
120 cm	DP 120 01 05 S01	311 \$	DP 120 21 05 S01	505 \$	DP 120 31 05 S01	553 \$	DP 120 55 05 S01	505 \$

EBAT Size	Inox Ayna Inox Mirror		Altın Ayna Gold Mirror		Bakır Ayna Bronze Mirror	
30 cm	DP 030 00 05 S01	141 \$	DP 030 20 05 S01	219 \$	DP 030 30 05 S01	243 \$
40 cm	DP 040 00 05 S01	153 \$	DP 040 20 05 S01	239 \$	DP 040 30 05 S01	263 \$
50 cm	DP 050 00 05 S01	169 \$	DP 050 20 05 S01	253 \$	DP 050 30 05 S01	277 \$
60 cm	DP 060 00 05 S01	196 \$	DP 060 20 05 S01	280 \$	DP 060 30 05 S01	304 \$
70 cm	DP 070 00 05 S01	223 \$	DP 070 20 05 S01	297 \$	DP 070 30 05 S01	321 \$
80 cm	DP 080 00 05 S01	233 \$	DP 080 20 05 S01	350 \$	DP 080 30 05 S01	383 \$
90 cm	DP 090 00 05 S01	275 \$	DP 090 20 05 S01	443 \$	DP 090 30 05 S01	491 \$
120 cm	DP 120 00 05 S01	338 \$	DP 120 20 05 S01	505 \$	DP 120 30 05 S01	553 \$



Size uygun sifon tipini siparişiniz esnasında ürün koduna ekleyiniz.
Please add the siphon type to the product code in your order.

S01

h : 60 mm
Debi: 42 lt/dk - Flow: 42 lt/min
Kokusuz / Odor free



S02

h : 70 mm
Debi: 48 lt/dk - Flow: 48 lt/min
Kokusuz / Odor free



S03

h : 30/80 mm
Kerot ø: 120mm - Core Drill Diameter ø: 120mm
Debi : 48 lt/dk - Flow: 48 lt/dk
Kokusuz / Odor free



S11

h : 60 mm
Debi: 42 lt/dk - Flow: 42 lt/min
Kokusuz / Odor free



S13

h : 60 mm
Kerot ø: 110 mm - Core Drill Diameter ø: 110 mm
Debi: 48 lt/dk - Flow: 48 lt/min
Kokusuz / Odor free



S14

h : 80 mm
Debi : 60 lt/dk - Flow: 60 lt/dk
Kokusuz / Odor free



S15

h : 60 mm
Debi: 42 lt/dk - Flow: 42 lt/min
Kokusuz / Odor free



S16

h : 80 mm
Debi: 60 lt/dk - Flow: 60 lt/min
Kokusuz / Odor free



S50/S95

Sifonsuz Direkt Bağlantı
(Direct Connection Without Siphon)
S50 for 2 inc (50 mm)
S95 for 4 inc (90 mm-110 mm)



PH PRODRAIN

Duş Alanlarında Fonksiyonel Çözümler: Mimari projeleriniz için eşsiz tasarım seçenekleri sunar.

Functional solutions in shower areas: Offers unique design options for your architectural projects.

PH PRODRAIN



PH DESIGN

Uygulama Kesit :

1. Döşeme Betonu / Covering Concrete
2. Tesviye Betonu / Levelling Concrete
3. Ph Dizayn Butil Bant / Ph Design Butil Bant
4. İzolasyon Katmanı / Insulation Layer
5. Yapıştırıcı / Adhesive
6. Kaplama Malzemesi / Covering

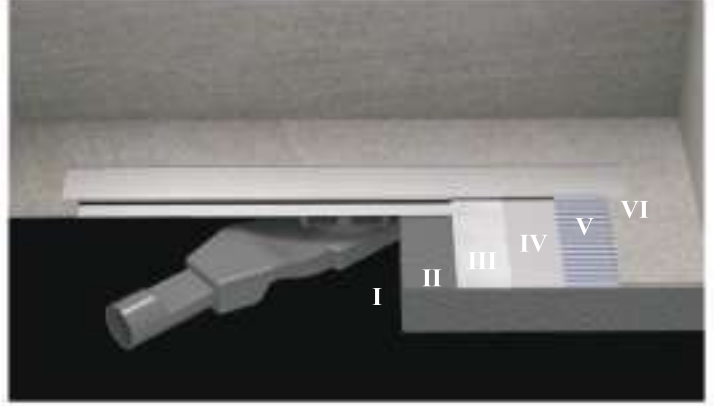

Sifon Tipi : S01

Kapak (1.5 mm kalınlık) / Top cover (1.5 mm)

Yükseklik Ayar Vidası / Height Adjustment Screw

Saç Tutucu Süzgeç / Hair Holder

Yalıtım Etekli Ana Gövde / Insulated Main Body

Patentli Contasız Bağlantı Parçası / Patented Without Gasket Part

360° Döner Sifon S01 / 360° Degree Rotating Flusher

Yükseklik Ayar Parçası / Height Adjustment Kit



55

S01



S13



S15



S16

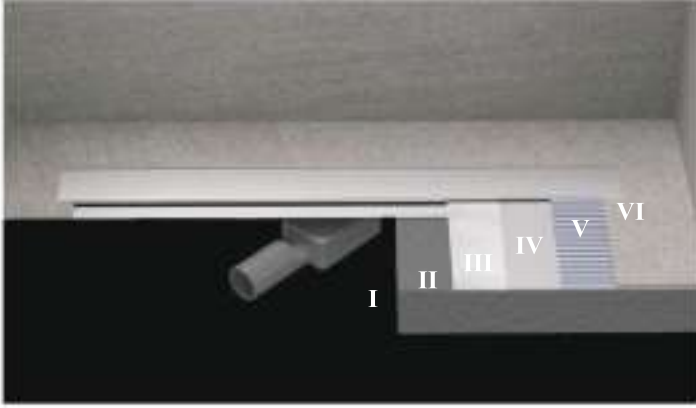

Uygulama Kesit :

1. Döşeme Betonu / Covering Concrete
2. Tesviye Betonu / Levelling Concrete
3. Ph Dizayn Butil Bant / Ph Design Butil Bant
4. İzolasyon Katmanı / Insulation Layer
5. Yapıştırıcı / Adhesive
6. Kaplama Malzemesi / Covering

Sifon Tipi : S02

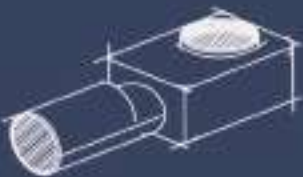

S02



S03



S11



S14

PRODRAIN
LINEAR

DRAINLINE

PH
Dizayn



PH DESIGN

Prodrain Linear serisi ile duş alanlarına modern , estetik ve kullanışlı çözümler sunuyor. Hemzemin uygulama karo ile bütünleşerek engelsiz banyolar yaratıyor. Yeni teknolojiyi kullanarak PATENTLİ CONTASIZ sistem ile sızdırmalıkta standartları yeniden belirleniyor.

Prodrain Linear serisi ürünler;

-Yalıtım etekli kaynaksız yekpare gövde, şap yüksekliğini için yükseklik ayar seti, farklı montaj yükseklikleri ve drenaj kapasiteleri ile projelere uygun alternatif mekanik çözümler sunan, 360 derece dönebilen yüksek drenaj kapasiteli koku fermatürlü S sifon, saç tutucu, 20 cm genişliğinde bütül bant, uygulama sonrası oluşabilecek kot farklılıklarını önleyen yükseklik ayar setini uygulama

EBAT Size	Inox Satinox	Satine Altın Satin Gold	Satine Bakır Satin Bronze	Siyah Black
30 cm	DD 030 01 00 S01 84 \$	DD 030 21 00 S01 181 \$	DD 030 31 00 S01 205 \$	DD 030 55 00 S01 181 \$
40 cm	DD 040 01 00 S01 95 \$	DD 040 21 00 S01 192 \$	DD 040 31 00 S01 216 \$	DD 040 55 00 S01 192 \$
50 cm	DD 050 01 00 S01 105 \$	DD 050 21 00 S01 202 \$	DD 050 31 00 S01 226 \$	DD 050 55 00 S01 202 \$
60 cm	DD 060 01 00 S01 116 \$	DD 060 21 00 S01 213 \$	DD 060 31 00 S01 237 \$	DD 060 55 00 S01 213 \$
70 cm	DD 070 01 00 S01 127 \$	DD 070 21 00 S01 224 \$	DD 070 31 00 S01 248 \$	DD 070 55 00 S01 224 \$
80 cm	DD 080 01 00 S01 138 \$	DD 080 21 00 S01 269 \$	DD 080 31 00 S01 302 \$	DD 080 55 00 S01 269 \$
90 cm	DD 090 01 00 S01 150 \$	DD 090 21 00 S01 344 \$	DD 090 31 00 S01 392 \$	DD 090 55 00 S01 344 \$
120 cm	DD 120 01 00 S01 195 \$	DD 120 21 00 S01 389 \$	DD 120 31 00 S01 437 \$	DD 120 55 00 S01 389 \$

EBAT Size	Inox Ayna Inox Mirror	Altın Ayna Gold Mirror	Bakır Ayna Bronze Mirror
30 cm	DD 030 00 00 S01 95 \$	DD 030 20 00 S01 181 \$	DD 030 30 00 S01 205 \$
40 cm	DD 040 00 00 S01 105 \$	DD 040 20 00 S01 192 \$	DD 040 30 00 S01 216 \$
50 cm	DD 050 00 00 S01 120 \$	DD 050 20 00 S01 202 \$	DD 050 30 00 S01 226 \$
60 cm	DD 060 00 00 S01 140 \$	DD 060 20 00 S01 213 \$	DD 060 30 00 S01 237 \$
70 cm	DD 070 00 00 S01 155 \$	DD 070 20 00 S01 224 \$	DD 070 30 00 S01 248 \$
80 cm	DD 080 00 00 S01 170 \$	DD 080 20 00 S01 269 \$	DD 080 30 00 S01 302 \$
90 cm	DD 090 00 00 S01 205 \$	DD 090 20 00 S01 344 \$	DD 090 30 00 S01 392 \$
120 cm	DD 120 00 00 S01 267 \$	DD 120 20 00 S01 389 \$	DD 120 30 00 S01 437 \$



Size uygun sifon tipini siparişiniz esnasında ürün koduna ekleyiniz.
Please add the siphon type to the product code in your order.

S01

h : 60 mm
Debi: 42 lt/dk - Flow: 42 lt/min
Kokusuz / Odor free



S02

h : 70 mm
Debi: 48 lt/dk - Flow: 48 lt/min
Kokusuz / Odor free



S03

h : 30/80 mm
Kerot ø: 120mm - Core Drill Diameter ø: 120mm
Debi : 48 lt/dk - Flow: 48 lt/dk
Kokusuz / Odor free



S11

h : 60 mm
Debi: 42 lt/dk - Flow: 42 lt/min
Kokusuz / Odor free



S13

h : 60 mm
Kerot ø: 110 mm - Core Drill Diameter ø: 110 mm
Debi: 48 lt/dk - Flow: 48 lt/min
Kokusuz / Odor free



S14

h : 80 mm
Debi : 60 lt/dk - Flow: 60 lt/dk
Kokusuz / Odor free



S15

h : 60 mm
Debi: 42 lt/dk - Flow: 42 lt/min
Kokusuz / Odor free



S16

h : 80 mm
Debi: 60 lt/dk - Flow: 60 lt/min
Kokusuz / Odor free



S50/S95

Sifonsuz Direkt Bağlantı
(Direct Connection Without Siphon)
S50 for 2 inc (50 mm)
S95 for 4 inc (90 mm-110 mm)



PRODRAIN
INVISIBLE

DRAINLINE

PH
Dizayn



PH DESIGN

Prodrain Invisible serisi ile duş alanlarına modern , estetik ve kullanışlı çözümler sunuyor. Hemzemin uygulama karo ile bütünleşerek engelsiz banyolar yaratıyor. Yeni teknolojiyi kullanarak PATENTLİ CONTASIZ sistem ile sızdırmalıkta standartları yeniden belirliyor.

Prodrain Invisible serisi ürünler;

-Yalıtım etekli kaynaksız yekpare gövde, şap yüksekliğini için yükseklik ayar seti, farklı montaj yükseklikleri ve drenaj kapasiteleri ile projelere uygun alternatif mekanik çözümler sunan, 360 derece dönebilen yüksek drenaj kapasiteli koku fermatürlü S sifon, saç tutucu, 20 cm genişliğinde bütül bant, uygulama sonrası oluşabilecek kot farklılıklarını önleyen yükseklik ayar setini uygulama

EBAT Size	Inox Satinox	
30 cm	DD 030 01 06 S01	110 \$
40 cm	DD 040 01 06 S01	125 \$
50 cm	DD 050 01 06 S01	140 \$
60 cm	DD 060 01 06 S01	155 \$
70 cm	DD 070 01 06 S01	175 \$
80 cm	DD 080 01 06 S01	185 \$
90 cm	DD 090 01 06 S01	203 \$
120 cm	DD 120 01 06 S01	233 \$

Size uygun sifon tipini siparişiniz esnasında ürün koduna ekleyiniz.
Please add the siphon type to the product code in your order.

S01

h : 60 mm
Debi: 42 lt/dk - Flow: 42 lt/min
Kokusuz / Odor free



S02

h : 70 mm
Debi: 48 lt/dk - Flow: 48 lt/min
Kokusuz / Odor free



S03

h : 30/80 mm
Karat ø: 120mm - Care Drill Diameter ø: 120mm
Debi : 48 lt/dk - Flow: 48 lt/dk
Kokusuz / Odor free



S11

h : 60 mm
Debi: 42 lt/dk - Flow: 42 lt/min
Kokusuz / Odor free



S13

h : 80 mm
Karat ø: 110 mm - Care Drill Diameter ø: 110 mm
Debi: 48 lt/dk - Flow: 48 lt/min
Kokusuz / Odor free



S14

h : 80 mm
Debi : 60 lt/dk - Flow: 60 lt/dk
Kokusuz / Odor free



S15

h : 60 mm
Debi: 42 lt/dk - Flow: 42 lt/min
Kokusuz / Odor free



S16

h : 80 mm
Debi: 60 lt/dk - Flow: 60 lt/min
Kokusuz / Odor free



S50/S95

Sifonsuz Direkt Bağlantı
(Direct Connection Without Siphon)
S50 for 2 inc (50 mm)
S95 for 4 inc (90 mm-110 mm)



PRODRAIN
GREEK

DRAINLINE

PH
Dizayn



PH DESIGN

Prodrain Greek serisi ile duř alanlarına modern , estetik ve kullanıřlı çözümler sunuyor. Hemzemin uygulama karo ile bütünleřerek engelsiz banyolar yaratıyor. Yeni teknolojiyi kullanarak PATENTLİ CONTASIZ sistem ile sızdırmalıkta standartları yeniden belirliyor.

Prodrain Greek serisi ürünler;

-Yalıtım etekli kaynaksız yekpare gövde, řap yüksekliđini için yükseklik ayar seti, farklı montaj yükseklikleri ve drenaj kapasiteleri ile projelere uygun alternatif mekanik çözümler sunan, 360 derece dönebilen yüksek drenaj kapasiteli koku fermatürlü S sifon, saç tutucu, 20 cm geniřliđinde bütül bant, uygulama sonrası oluşabilecek kot farklılıklarını önleyen yükseklik ayar setini uygulama kolaylıđı sağlayacak řekilde standardize ederek, tek parça ürün olarak birleřtiriyor ve kullanıcılara kolay montaj avantajı sunuyor.

EBAT Size	Inox Satinox	Satine Altın Satin Gold	Satine Bakır Satin Bronze	Siyah Black
30 cm	DD 030 01 01 S01 102 \$	DD 030 21 01 S01 199 \$	DD 030 31 01 S01 223 \$	DD 030 55 01 S01 199 \$
40 cm	DD 040 01 01 S01 114 \$	DD 040 21 01 S01 211 \$	DD 040 31 01 S01 235 \$	DD 040 55 01 S01 211 \$
50 cm	DD 050 01 01 S01 126 \$	DD 050 21 01 S01 223 \$	DD 050 31 01 S01 247 \$	DD 050 55 01 S01 223 \$
60 cm	DD 060 01 01 S01 150 \$	DD 060 21 01 S01 247 \$	DD 060 31 01 S01 271 \$	DD 060 55 01 S01 247 \$
70 cm	DD 070 01 01 S01 168 \$	DD 070 21 01 S01 265 \$	DD 070 31 01 S01 289 \$	DD 070 55 01 S01 265 \$
80 cm	DD 080 01 01 S01 186 \$	DD 080 21 01 S01 317 \$	DD 080 31 01 S01 350 \$	DD 080 55 01 S01 317 \$
90 cm	DD 090 01 01 S01 216 \$	DD 090 21 01 S01 410 \$	DD 090 31 01 S01 458 \$	DD 090 55 01 S01 410 \$
120 cm	DD 120 01 01 S01 281 \$	DD 120 21 01 S01 475 \$	DD 120 31 01 S01 523 \$	DD 120 55 01 S01 475 \$

EBAT Size	Inox Ayna Inox Mirror	Altın Ayna Gold Mirror	Bakır Ayna Bronze Mirror
30 cm	DD 030 00 01 S01 129 \$	DD 030 20 01 S01 199 \$	DD 030 30 01 S01 223 \$
40 cm	DD 040 00 01 S01 144 \$	DD 040 20 01 S01 211 \$	DD 040 30 01 S01 235 \$
50 cm	DD 050 00 01 S01 159 \$	DD 050 20 01 S01 223 \$	DD 050 30 01 S01 247 \$
60 cm	DD 060 00 01 S01 189 \$	DD 060 20 01 S01 247 \$	DD 060 30 01 S01 271 \$
70 cm	DD 070 00 01 S01 212 \$	DD 070 20 01 S01 265 \$	DD 070 30 01 S01 289 \$
80 cm	DD 080 00 01 S01 234 \$	DD 080 20 01 S01 317 \$	DD 080 30 01 S01 350 \$
90 cm	DD 090 00 01 S01 272 \$	DD 090 20 01 S01 410 \$	DD 090 30 01 S01 458 \$
120 cm	DD 120 00 01 S01 354 \$	DD 120 20 01 S01 475 \$	DD 120 30 01 S01 523 \$



Size uygun sifon tipini siparişiniz esnasında ürün koduna ekleyiniz.
Please add the siphon type to the product code in your order.

S01

h : 60 mm
Debi: 42 lt/dk - Flow: 42 lt/min
Kokusuz / Odor free



S02

h : 70 mm
Debi: 48 lt/dk - Flow: 48 lt/min
Kokusuz / Odor free



S03

h : 30/80 mm
Karat ø: 120mm - Care Drill Diameter ø: 120mm
Debi : 48 lt/dk - Flow: 48 lt/dk
Kokusuz / Odor free



S11

h : 60 mm
Debi: 42 lt/dk - Flow: 42 lt/min
Kokusuz / Odor free



S13

h : 60 mm
Karat ø: 110 mm - Care Drill Diameter ø: 110 mm
Debi: 48 lt/dk - Flow: 48 lt/min
Kokusuz / Odor free



S14

h : 80 mm
Debi : 60 lt/dk - Flow: 60 lt/dk
Kokusuz / Odor free



S15

h : 60 mm
Debi: 42 lt/dk - Flow: 42 lt/min
Kokusuz / Odor free



S16

h : 80 mm
Debi: 60 lt/dk - Flow: 60 lt/min
Kokusuz / Odor free



S50/S95

Sifonsuz Direkt Bağlantı
(Direct Connection Without Siphon)
S50 for 2 inc (50 mm)
S95 for 4 inc (90 mm-110 mm)



PH SMARTLINE

Smartline serisi duş kanalları sunduğu tasarım, üstün kalite ve renk çeşitliliği ile herkesin hayalindeki banyoyu gerçeğe dönüştürüyor.

Smartline series shower channels turn everyone's dream bathroom into reality with its design, superior quality and color variety.

PH SMARTLINE

Seramikler ile uyumlu trend renklerle bütünsel tasarım. PH Smartline duş kanallarının metalik trend renkleri ile banyolarınıza farklı dokunuşlar.

Holistic design with trend colors compatible with ceramics. Different touches to your bathrooms with metallic trend colors of PH Smartline shower channels.

304

stainless
steel

51l/min



+
easy
to clean



odor prevent
system



360°
base
rotation



60
mm

Ø50
output



easy
assembling

Uygulama Kesit :

1. Döşeme Betonu / Covering Concrete
2. Tesviye Betonu / Levelling Concrete
3. Ph Dizayn Butil Bant / Ph Design Butil Bant
4. İzolasyon Katmanı / Insulation Layer
5. Yapıştırıcı / Adhesive
6. Kaplama Malzemesi / Covering

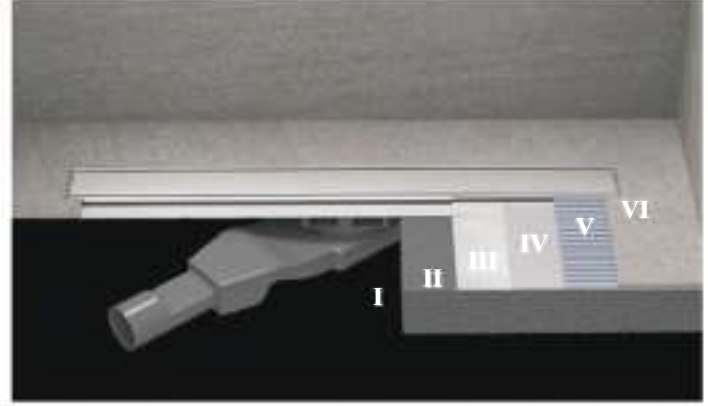

Sifon Tipi : S01

Kapak (1.2 mm kalınlık) / Top Cover (1.2 mm thickness)

Saç Tutucu Süzgeç / Hair Holder

Ana Gövde Eğimli (1 mm kalınlık) / Main Body Sloped (1mm)

304 kalite paslanmaz çelik / 304 quality stainless steel

Patentli Contasız Bağlantı Parçası / Patented Without Gasket Part

Yalıtım Membranı / Insulation Membran

İzolasyon Flanşı Polipropilen / Insulation Flange Polipropilen

Yükseklik Ayar Parçası / Height Adjustment Kit

360° Döner Sifon S01 / 360° Rotating Siphon S01



65

S01



S13



S15



S16



Uygulama Kesit :

1. Döşeme Betonu / Covering Concrete
2. Tesviye Betonu / Levelling Concrete
3. Ph Dizayn Butil Bant / Ph Design Butil Bant
4. İzolasyon Katmanı / Insulation Layer
5. Yapıştırıcı / Adhesive
6. Kaplama Malzemesi / Covering

Sifon Tipi : S13



Kapak (1.2 mm kalınlık) / Top Cover (1.2 mm thickness)

Saç Tutucu Süzgeç / Hair Holder

**Ana Gövde Eğimli (1 mm kalınlık) / Main Body Sloped (1mm)
304 kalite paslanmaz çelik / 304 quality stainless steel**

Patentli Contasız Bağlantı Parçası / Patented Without Gasket Part

Yalıtım Membranı / Insulation Membran

İzolasyon Flanşı Polipropilen / Insulation Flange Polipropilen

360° Döner Sifon S013 / 360° Rotating Siphon S013

Yükseklik Ayar Parçası / Height Adjustment Kit



S08



S09



S17



S18

SMARTLINE
LINEAR

DRAINLINE

PH
Dizayn



PH DESIGN

Smartline Linear Serisi ile duş alanlarına modern , estetik ve kullanışlı çözümler sunuyor. Hemzemin uygulama karo ile bütünleşerek engelsiz banyolar yaratıyor. Yeni teknolojiyi kullanarak PATENTLİ CONTASIZ sistem ile sızdırmalıkta standartları yeniden belirleniyor.

Smartline Linear Serisi Ürünler;

-Yalıtım etekli kaynaksız yekpare gövde, şap yüksekliğini için yükseklik ayar seti, farklı montaj yükseklikleri ve drenaj kapasiteleri ile projelere uygun alternatif mekanik çözümler sunan, 360 derece dönebilen yüksek drenaj kapasiteli koku fermatürlü S sifon, saç tutucu, 20 cm genişliğinde bütül bant, uygulama sonrası oluşabilecek kot farklılıklarını önleyen yükseklik ayar setini uygulama kolaylığı sağlayacak şekilde standardize ederek, tek parça ürün olarak birleştiriyor ve kullanıcılara kolay montaj avantajı sunuyor.

EBAT Size	Inox Satinox		Inox Ayna Inox Mirror	
40 cm	DC 040 01 00 S01	85 \$	DC 040 00 00 S01	95 \$
60 cm	DC 060 01 00 S01	100 \$	DC 060 00 00 S01	112 \$

Size uygun sifon tipini siparişiniz esnasında ürün koduna ekleyiniz.
Please add the siphon type to the product code in your order.

S01

h : 60 mm
Debi: 42 lt/dk - Flow: 42 lt/min
Kokusuz / Odor free



S08

h : 30/80 mm
Karat ø: 110 mm - Care Drill Diameter ø: 110 mm
Debi : 48 lt/dk - Flow: 48 lt/dk
Kokusuz / Odor free



S09

h : 60 mm
Debi: 51 lt/dk - Flow: 51 lt/min
Kokusuz / Odor free



S13

h : 60 mm
Karat ø: 110 mm - Care Drill Diameter ø: 110 mm
Debi: 48 lt/dk - Flow: 48 lt/min
Kokusuz / Odor free



S15

h : 60 mm
Debi: 42 lt/dk - Flow: 42 lt/min
Kokusuz / Odor free



S16

h : 80 mm
Debi: 60 lt/dk - Flow: 60 lt/min
Kokusuz / Odor free



S17

h : 80 mm
Debi: 60 lt/dk - Flow: 60 lt/min
Kokusuz / Odor free



S18

h : 60 mm
Debi: 42 lt/dk - Flow: 42 lt/min
Kokusuz / Odor free



S50/S95

Sifonsuz Direkt Bağlantı
(Direct Connection Without Siphon)
S50 for 2 inc (50 mm)
S95 for 4 inc (90 mm-110 mm)



SMARTLINE
TRENDY

DRAINLINE

PH
Dizayn



PH DESIGN

Smartline Trendy Serisi ile duř alanlarına modern , estetik ve kullanıřlı çözümler sunuyor. Hemzemin uygulama karo ile bütünleřerek engelsiz banyolar yaratıyor. Yeni teknolojiyi kullanarak PATENTLİ CONTASIZ sistem ile sızdırmalıktá standartları yeniden belirleniyor.

Optimum uzunluk. Montaj sırasında duř alanlarının ölçülerine göre kesilebilir, linear duvardan duvara tasarıma net çizgilere sahip
69 Smartline Trendy duř serisi modern bir tasarım dili sunuyor.

EBAT Size	Inox Satinox		Satine Altın Satin Gold		Satine Bakır Satin Bronze		Siyah Black	
40 cm	DC 040 01 09 S01	100 \$	DC 040 21 09 S01	207 \$	DC 040 31 09 S01	231 \$	DC 040 55 09 S01	207 \$
50 cm	DC 050 01 09 S01	105 \$	DC 050 21 09 S01	222 \$	DC 050 31 09 S01	246 \$	DC 050 55 09 S01	222 \$
60 cm	DC 060 01 09 S01	140 \$	DC 060 21 09 S01	237 \$	DC 060 31 09 S01	261 \$	DC 060 55 09 S01	237 \$
70 cm	DC 070 01 09 S01	150 \$	DC 070 21 09 S01	247 \$	DC 070 31 09 S01	271 \$	DC 070 55 09 S01	247 \$
80 cm	DC 080 01 09 S01	155 \$	DC 080 21 09 S01	252 \$	DC 080 31 09 S01	319 \$	DC 080 55 09 S01	252 \$
90 cm	DC 090 01 09 S01	160 \$	DC 090 21 09 S01	291 \$	DC 090 31 09 S01	402 \$	DC 090 55 09 S01	291 \$
100 cm	DC 100 01 09 S01	165 \$	DC 100 21 09 S01	359 \$	DC 100 31 09 S01	407 \$	DC 100 55 09 S01	359 \$
120 cm	DC 120 01 09 S01	185 \$	DC 120 21 09 S01	379 \$	DC 120 31 09 S01	427 \$	DC 120 55 09 S01	379 \$

EBAT Size	Inox Ayna Inox Mirror		Altın Ayna Gold Mirror		Bakır Ayna Bronze Mirror	
40 cm	DC 040 00 09 S01	115 \$	DC 040 20 09 S01	207 \$	DC 040 30 09 S01	231 \$
50 cm	DC 050 00 09 S01	121 \$	DC 050 20 09 S01	222 \$	DC 050 30 09 S01	246 \$
60 cm	DC 060 00 09 S01	161 \$	DC 060 20 09 S01	237 \$	DC 060 30 09 S01	261 \$
70 cm	DC 070 00 09 S01	173 \$	DC 070 20 09 S01	247 \$	DC 070 30 09 S01	271 \$
80 cm	DC 080 00 09 S01	178 \$	DC 080 20 09 S01	252 \$	DC 080 30 09 S01	319 \$
90 cm	DC 090 00 09 S01	184 \$	DC 090 20 09 S01	291 \$	DC 090 30 09 S01	402 \$
100 cm	DC 100 00 09 S01	190 \$	DC 100 20 09 S01	359 \$	DC 100 30 09 S01	407 \$
120 cm	DC 120 00 09 S01	213 \$	DC 120 20 09 S01	379 \$	DC 120 30 09 S01	427 \$



Size uygun sifon tipini siparişiniz esnasında ürün koduna ekleyiniz.
Please add the siphon type to the product code in your order.

S01

h : 60 mm
Debi: 42 lt/dk - Flow: 42 lt/min
Kokusuz / Odor free



S08

h : 30/80 mm
Karot ø: 110 mm - Core Drill Diameter ø: 110 mm
Debi : 48 lt/dk - Flow: 48 lt/dk
Kokusuz / Odor free



S09

h : 60 mm
Debi: 51 lt/dk - Flow: 51 lt/min
Kokusuz / Odor free



S13

h : 60 mm
Karot ø: 110 mm - Core Drill Diameter ø: 110 mm
Debi: 48 lt/dk - Flow: 48 lt/min
Kokusuz / Odor free



S15

h : 60 mm
Debi: 42 lt/dk - Flow: 42 lt/min
Kokusuz / Odor free



S16

h : 80 mm
Debi: 60 lt/dk - Flow: 60 lt/min
Kokusuz / Odor free



S17

h : 80 mm
Debi: 60 lt/dk - Flow: 60 lt/min
Kokusuz / Odor free



S18

h : 60 mm
Debi: 42 lt/dk - Flow: 42 lt/min
Kokusuz / Odor free



S50/S95

Sifonsuz Direkt Bağlantı
(Direct Connection Without Siphon)
S50 for 2 inc (50 mm)
S95 for 4 inc (90 mm-110 mm)



SMARTLINE
ICON

DRAINLINE

PH
Dizayn



PH DESIGN

Smartline Icon Serisi ile duş alanlarına modern , estetik ve kullanışlı çözümler sunuyor. Hemzemin uygulama karo ile bütünleşerek engelsiz banyolar yaratıyor. Yeni teknolojiyi kullanarak PATENTLİ CONTASIZ sistem ile sızdırmalıkta standartları yeniden belirliyor.

Smartline Icon Serisi Ürünler;

-Yalıtım etekli kaynaksız yekpare gövde, şap yüksekliğini için yükseklik ayar seti, farklı montaj yükseklikleri ve drenaj kapasiteleri ile projelere uygun alternatif mekanik çözümler sunan, 360 derece dönebilen yüksek drenaj kapasiteli koku fermatürlü S sifon, saç tutucu, 20 cm genişliğinde bütül bant, uygulama sonrası oluşabilecek kot farklılıklarını önleyen yükseklik ayar setini uygulama kolaylığı sağlayacak şekilde standardize ederek, tek parça ürün olarak birleştiriyor ve kullanıcılara kolay montaj avantajı sunuyor.

EBAT Size	Inox Satinox		Satine Altın Satin Gold		Satine Bakır Satin Bronze		Siyah Black	
40 cm	DC 040 01 10 S01	100 \$	DC 040 21 10 S01	207 \$	DC 040 31 10 S01	231 \$	DC 040 55 10 S01	207 \$
50 cm	DC 050 01 10 S01	105 \$	DC 050 21 10 S01	222 \$	DC 050 31 10 S01	246 \$	DC 050 55 10 S01	222 \$
60 cm	DC 060 01 10 S01	140 \$	DC 060 21 10 S01	237 \$	DC 060 31 10 S01	261 \$	DC 060 55 10 S01	237 \$
70 cm	DC 070 01 10 S01	150 \$	DC 070 21 10 S01	247 \$	DC 070 31 10 S01	271 \$	DC 070 55 10 S01	247 \$
80 cm	DC 080 01 10 S01	155 \$	DC 080 21 10 S01	252 \$	DC 080 31 10 S01	319 \$	DC 080 55 10 S01	252 \$
90 cm	DC 090 01 10 S01	160 \$	DC 090 21 10 S01	291 \$	DC 090 31 10 S01	402 \$	DC 090 55 10 S01	291 \$
100 cm	DC 100 01 10 S01	165 \$	DC 100 21 10 S01	359 \$	DC 100 31 10 S01	407 \$	DC 100 55 10 S01	359 \$
120 cm	DC 120 01 10 S01	185 \$	DC 120 21 10 S01	379 \$	DC 120 31 10 S01	427 \$	DC 120 55 10 S01	379 \$

EBAT Size	Inox Ayna Inox Mirror		Altın Ayna Gold Mirror		Bakır Ayna Bronze Mirror	
40 cm	DC 040 00 10 S01	115 \$	DC 040 20 10 S01	207 \$	DC 040 30 10 S01	231 \$
50 cm	DC 050 00 10 S01	121 \$	DC 050 20 10 S01	222 \$	DC 050 30 10 S01	246 \$
60 cm	DC 060 00 10 S01	161 \$	DC 060 20 10 S01	237 \$	DC 060 30 10 S01	261 \$
70 cm	DC 070 00 10 S01	173 \$	DC 070 20 10 S01	247 \$	DC 070 30 10 S01	271 \$
80 cm	DC 080 00 10 S01	178 \$	DC 080 20 10 S01	252 \$	DC 080 30 10 S01	319 \$
90 cm	DC 090 00 10 S01	184 \$	DC 090 20 10 S01	291 \$	DC 090 30 10 S01	402 \$
100 cm	DC 100 00 10 S01	190 \$	DC 100 20 10 S01	359 \$	DC 100 30 10 S01	407 \$
120 cm	DC 120 00 10 S01	213 \$	DC 120 20 10 S01	379 \$	DC 120 30 10 S01	427 \$



Size uygun sifon tipini siparişiniz esnasında ürün koduna ekleyiniz.
Please add the siphon type to the product code in your order.

S01

h : 60 mm
Debi: 42 lt/dk - Flow: 42 lt/min
Kokusuz / Odor free



S08

h : 30/80 mm
Karot ø: 110 mm - Core Drill Diameter ø: 110 mm
Debi : 48 lt/dk - Flow: 48 lt/dk
Kokusuz / Odor free



S09

h : 60 mm
Debi: 51 lt/dk - Flow: 51 lt/min
Kokusuz / Odor free



S13

h : 60 mm
Karot ø: 110 mm - Core Drill Diameter ø: 110 mm
Debi: 48 lt/dk - Flow: 48 lt/min
Kokusuz / Odor free



S15

h : 60 mm
Debi: 42 lt/dk - Flow: 42 lt/min
Kokusuz / Odor free



S16

h : 80 mm
Debi: 60 lt/dk - Flow: 60 lt/min
Kokusuz / Odor free



S17

h : 80 mm
Debi: 60 lt/dk - Flow: 60 lt/min
Kokusuz / Odor free



S18

h : 60 mm
Debi: 42 lt/dk - Flow: 42 lt/min
Kokusuz / Odor free



S50/S95

Sifonsuz Direkt Bağlantı
(Direct Connection Without Siphon)
S50 for 2 inc (50 mm)
S95 for 4 inc (90 mm-110 mm)



SMARTLINE
QDRAIN

DRAINLINE

PH
Dizayn



PH DESIGN

Smartline Qdrain Serisi ile duş alanlarına modern , estetik ve kullanışlı çözümler sunuyor. Hemzemin uygulama karo ile bütünleşerek engelsiz banyolar yaratıyor. Yeni teknolojiyi kullanarak PATENTLİ CONTASIZ sistem ile sızdırmalıkta standartları yeniden belirleniyor.

Smartline Qdrain Serisi Ürünler;

-Yalıtım etekli kaynaksız yekpare gövde, şap yüksekliğini için yükseklik ayar seti, farklı montaj yükseklikleri ve drenaj kapasiteleri ile projelere uygun alternatif mekanik çözümler sunan, 360 derece dönebilen yüksek drenaj kapasiteli koku fermatürlü S sifon, saç tutucu, 20 cm genişliğinde bütül bant, uygulama sonrası oluşabilecek kot farklılıklarını önleyen yükseklik ayar setini uygulama

73 kolaylığı sağlayacak şekilde standardize ederek, tek parça ürün olarak birleştiriyor ve kullanıcılara kolay montaj avantajı sunuyor.

EBAT Size	Inox Satinox		Inox Ayna Inox Mirror	
40 cm	DC 040 01 08 S01	95 \$	DC 040 00 08 S01	110 \$
60 cm	DC 060 01 08 S01	115 \$	DC 060 00 08 S01	130 \$

Size uygun sifon tipini siparişiniz esnasında ürün koduna ekleyiniz.
Please add the siphon type to the product code in your order.

S01

h : 60 mm
Debi: 42 lt/dk - Flow: 42 lt/min
Kokusuz / Odor free



S08

h : 30/80 mm
Karat ø: 110 mm - Care Drill Diameter ø: 110 mm
Debi : 48 lt/dk - Flow: 48 lt/dk
Kokusuz / Odor free



S09

h : 60 mm
Debi: 51 lt/dk - Flow: 51 lt/min
Kokusuz / Odor free



S13

h : 60 mm
Karat ø: 110 mm - Care Drill Diameter ø: 110 mm
Debi: 48 lt/dk - Flow: 48 lt/min
Kokusuz / Odor free



S15

h : 60 mm
Debi: 42 lt/dk - Flow: 42 lt/min
Kokusuz / Odor free



S16

h : 80 mm
Debi: 60 lt/dk - Flow: 60 lt/min
Kokusuz / Odor free



S17

h : 80 mm
Debi: 60 lt/dk - Flow: 60 lt/min
Kokusuz / Odor free



S18

h : 60 mm
Debi: 42 lt/dk - Flow: 42 lt/min
Kokusuz / Odor free



S50/S95

Sifonsuz Direkt Bağlantı
(Direct Connection Without Siphon)
S50 for 2 inc (50 mm)
S95 for 4 inc (90 mm-110 mm)



SMARTLINE
SLOT

DRAINLINE

PH
Dizayn



PH DESIGN

Smartline Slot Serisi ile duř alanlarına modern , estetik ve kullanıřlı çözümler sunuyor. Hemzemin uygulama karo ile bütünleřerek engelsiz banyolar yaratıyor. Yeni teknolojiyi kullanarak PATENTLİ CONTASIZ sistem ile sızdırmalıktaki standartları yeniden belirliyor.

Smartline Slot Serisi Ürünler;

-Yalıtım etekli kaynaksız yekpare gövde , řap yüksekliđini için yükseklik ayar seti, farklı montaj yükseklikleri ve drenaj kapasiteleri ile projelere uygun alternatif mekanik çözümler sunan, 360 derece dönebilen yüksek drenaj kapasiteli koku fermatürlü S sifon, saç tutucu, 20 cm genişliğinde bütül bant, uygulama sonrası oluşabilecek kot farklılıklarını önleyen yükseklik ayar setini uygulama

75

kolaylıđı sağlayacak řekilde standardize ederek, tek parça ürün olarak birleřtiriyor ve kullanıcılara kolay montaj avantajı sunuyor.

EBAT Size	Inox Satinox	Inox Ayna Inox Mirror
40 cm	DC 040 01 11 S01 95 \$	DC 040 00 11 S01 110 \$
60 cm	DC 060 01 11 S01 115 \$	DC 060 00 11 S01 130 \$

Size uygun sifon tipini siparişiniz esnasında ürün koduna ekleyiniz.
Please add the siphon type to the product code in your order.

S01

h : 60 mm
Debi: 42 lt/dk - Flow: 42 lt/min
Kokusuz / Odor free



S08

h : 30/80 mm
Karat ø: 110 mm - Care Drill Diameter ø: 110 mm
Debi : 48 lt/dk - Flow: 48 lt/dk
Kokusuz / Odor free



S09

h : 60 mm
Debi: 51 lt/dk - Flow: 51 lt/min
Kokusuz / Odor free



S13

h : 60 mm
Karat ø: 110 mm - Care Drill Diameter ø: 110 mm
Debi: 48 lt/dk - Flow: 48 lt/min
Kokusuz / Odor free



S15

h : 60 mm
Debi: 42 lt/dk - Flow: 42 lt/min
Kokusuz / Odor free



S16

h : 80 mm
Debi: 60 lt/dk - Flow: 60 lt/min
Kokusuz / Odor free



S17

h : 80 mm
Debi: 60 lt/dk - Flow: 60 lt/min
Kokusuz / Odor free



S18

h : 60 mm
Debi: 42 lt/dk - Flow: 42 lt/min
Kokusuz / Odor free



S50/S95

Sifonsuz Direkt Bağlantı
(Direct Connection Without Siphon)
S50 for 2 inc (50 mm)
S95 for 4 inc (90 mm-110 mm)



PH COMPACTLINE









Yalın ve şık formu ile banyonuzu ihtiyaçlarınıza göre tasarlayın. Compactline duş kanalı çözümleri, tüm ihtiyaçların karşılandığı sade ve zarif banyolar yaratıyor.

Design your bathroom according to your needs with simple, stylish form. Compactline shower channel solutions create simple and elegant bathrooms where all needs are met.

PH COMPACTLINE

Compactline akıllı banyo çözümleri ile sıhhi tesisat mühendisine, tesisatçıya ve son kullanıcıya fonksiyonel çözümler sunar.

Compactline offers functional solutions to the plumbing engineer, plumber and end user with its smart bathroom solutions.

 360° base rotation	 60 mm	 Ø50 output	 304 stainless steel
 + easy to clean	 odor prevent system	 51l/min	 easy assembling

Uygulama Kesit :

1. Döşeme Betonu / Covering Concrete
2. Tesviye Betonu / Levelling Concrete
3. Ph Dizayn Butil Bant / Ph Design Butil Bant
4. İzolasyon Katmanı / Insulation Layer
5. Yapıştırıcı / Adhesive
6. Kaplama Malzemesi / Covering

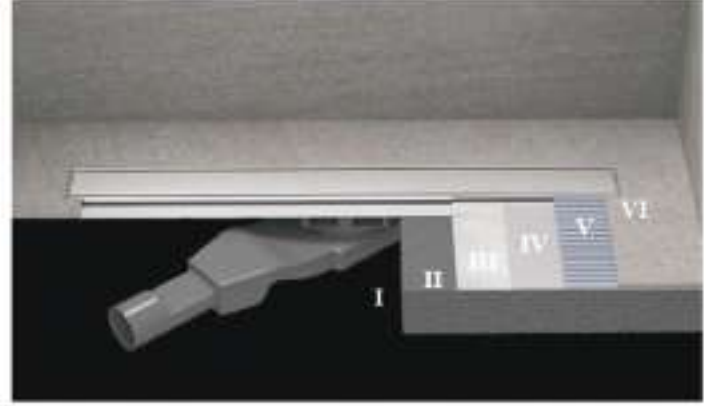

Sifon Tipi : S01

Kapak (1.2 mm kalınlık) / Top Cover (1.2 mm thickness)

Saç Tutucu Süzgeç / Hair Holder

Ana Gövde Eğimli (1 mm kalınlık) / Main Body Sloped (1mm)

304 kalite paslanmaz çelik / 304 quality stainless steel

Patentli Contasız Bağlantı Parçası / Patented Without Gasket Part

Yalıtım Membranı / Insulation Membran

İzolasyon Flanşı Polipropilen / Insulation Flange Polipropilen

Yükseklik Ayar Parçası / Height Adjustment Kit

360° Döner Sifon S01 / 360° Rotating Siphon S01

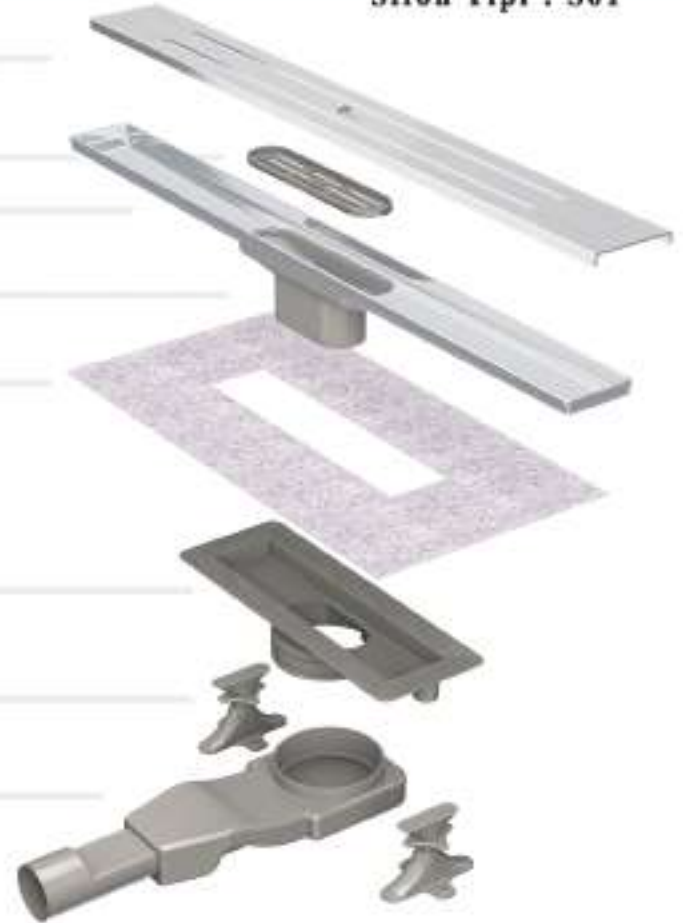

79

S01



S13



S15



S16



Uygulama Kesit :

1. Döşeme Betonu / Covering Concrete
2. Tesviye Betonu / Levelling Concrete
3. Ph Dizayn Butil Bant / Ph Design Butil Bant
4. İzolasyon Katmanı / Insulation Layer
5. Yapıştırıcı / Adhesive
6. Kaplama Malzemesi / Covering

Sifon Tipi : S13

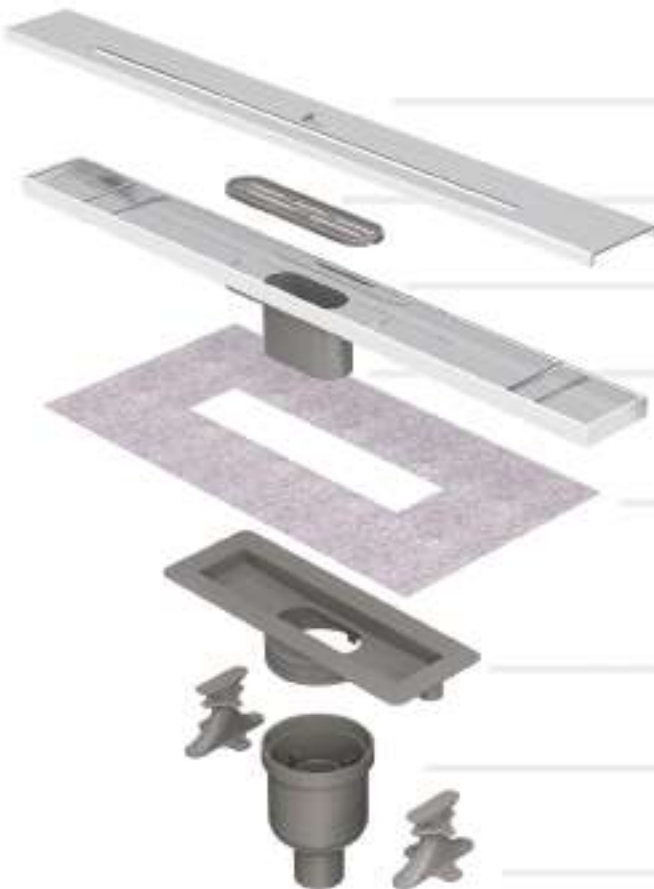

Kapak (1.2 mm kalınlık) / Top Cover (1.2 mm thickness)

Saç Tutucu Süzgeç / Hair Holder

**Ana Gövde Eğimli (1 mm kalınlık) / Main Body Sloped (1mm)
304 kalite paslanmaz çelik / 304 quality stainless steel**

Patentli Contasız Bağlantı Parçası / Patented Without Gasket Part

Yalıtım Membranı / Insulation Membran

İzolasyon Flanşı Polipropilen / Insulation Flange Polipropilen

360° Döner Sifon S013 / 360° Rotating Siphon S013

Yükseklik Ayar Parçası / Height Adjustment Kit



S08



S09



S17



S18

COMPACTLINE
TRENDY

DRAINLINE

PH
Dizayn



PH DESIGN

Compactline Trendy Serisi ile duş alanlarına modern , estetik ve kullanışlı çözümler sunuyor. Hemzemin uygulama karo ile bütünleşerek engelsiz banyolar yaratıyor. Yeni teknolojiyi kullanarak PATENTLİ CONTASIZ sistem ile sızdırmalıkta standartları yeniden belirleniyor.

Optimum uzunluk. Montaj sırasında duş alanlarının ölçülerine göre kesilebilir, linear duvardan duvara tasarıma net çizgilere sahip Smartline Trendy duş serisi modern bir tasarım dili sunuyor.

EBAT Size	Inox Satinox		Satine Altın Satin Gold		Satine Bakır Satin Bronze		Siyah Black	
40 cm	DF 040 01 09 S01	100 \$	DF 040 21 09 S01	197 \$	DF 040 31 09 S01	221 \$	DF 040 55 09 S01	197 \$
50 cm	DF 050 01 09 S01	105 \$	DF 050 21 09 S01	202 \$	DF 050 31 09 S01	226 \$	DF 050 55 09 S01	202 \$
60 cm	DF 060 01 09 S01	110 \$	DF 060 21 09 S01	207 \$	DF 060 31 09 S01	231 \$	DF 060 55 09 S01	207 \$
70 cm	DF 070 01 09 S01	115 \$	DF 070 21 09 S01	212 \$	DF 070 31 09 S01	236 \$	DF 070 55 09 S01	212 \$
80 cm	DF 080 01 09 S01	120 \$	DF 080 21 09 S01	251 \$	DF 080 31 09 S01	284 \$	DF 080 55 09 S01	251 \$
90 cm	DF 090 01 09 S01	125 \$	DF 090 21 09 S01	319 \$	DF 090 31 09 S01	367 \$	DF 090 55 09 S01	319 \$
100 cm	DF 100 01 09 S01	130 \$	DF 100 21 09 S01	324 \$	DF 100 31 09 S01	372 \$	DF 100 55 09 S01	324 \$
120 cm	DF 120 01 09 S01	150 \$	DF 120 21 09 S01	344 \$	DF 120 31 09 S01	392 \$	DF 120 55 09 S01	344 \$

EBAT Size	Inox Ayna Inox Mirror		Altın Ayna Gold Mirror		Bakır Ayna Bronze Mirror	
40 cm	DF 040 00 09 S01	115 \$	DF 040 20 09 S01	197 \$	DF 040 30 09 S01	221 \$
50 cm	DF 050 00 09 S01	121 \$	DF 050 20 09 S01	202 \$	DF 050 30 09 S01	226 \$
60 cm	DF 060 00 09 S01	127 \$	DF 060 20 09 S01	207 \$	DF 060 30 09 S01	231 \$
70 cm	DF 070 00 09 S01	132 \$	DF 070 20 09 S01	212 \$	DF 070 30 09 S01	236 \$
80 cm	DF 080 00 09 S01	138 \$	DF 080 20 09 S01	251 \$	DF 080 30 09 S01	284 \$
90 cm	DF 090 00 09 S01	144 \$	DF 090 20 09 S01	319 \$	DF 090 30 09 S01	367 \$
100 cm	DF 100 00 09 S01	150 \$	DF 100 20 09 S01	324 \$	DF 100 30 09 S01	372 \$
120 cm	DF 120 00 09 S01	173 \$	DF 120 20 09 S01	344 \$	DF 120 30 09 S01	392 \$



Size uygun sifon tipini siparişiniz esnasında ürün koduna ekleyiniz.
Please add the siphon type to the product code in your order.

S01

h : 60 mm
Debi: 42 lt/dk - Flow: 42 lt/min
Kokusuz / Odor free



S08

h : 30/80 mm
Karat ø: 110 mm - Care Drill Diameter ø: 110 mm
Debi : 48 lt/dk - Flow: 48 lt/dk
Kokusuz / Odor free



S09

h : 60 mm
Debi: 51 lt/dk - Flow: 51 lt/min
Kokusuz / Odor free



S13

h : 60 mm
Karat ø: 110 mm - Care Drill Diameter ø: 110 mm
Debi: 48 lt/dk - Flow: 48 lt/min
Kokusuz / Odor free



S15

h : 60 mm
Debi: 42 lt/dk - Flow: 42 lt/min
Kokusuz / Odor free



S16

h : 80 mm
Debi: 60 lt/dk - Flow: 60 lt/min
Kokusuz / Odor free



S17

h : 80 mm
Debi: 60 lt/dk - Flow: 60 lt/min
Kokusuz / Odor free



S18

h : 60 mm
Debi: 42 lt/dk - Flow: 42 lt/min
Kokusuz / Odor free



S50/S95

Sifonsuz Direkt Bağlantı
(Direct Connection Without Siphon)
S50 for 2 inc (50 mm)
S95 for 4 inc (90 mm-110 mm)



COMPACTLINE
ICON

DRAINLINE

PH
Dizayn



PH DESIGN

Compactline Icon Serisi ile duş alanlarına modern , estetik ve kullanışlı çözümler sunuyor. Hemzemin uygulama karo ile bütünleşerek engelsiz banyolar yaratıyor. Yeni teknolojiyi kullanarak PATENTLİ CONTASIZ sistem ile sızdırmalıkta standartları yeniden belirleniyor.

Compactline Icon Serisi Ürünler;

-Yalıtım etekli kaynaksız yekpare gövde, şap yüksekliğini için yükseklik ayar seti, farklı montaj yükseklikleri ve drenaj kapasiteleri ile projelere uygun alternatif mekanik çözümler sunan, 360 derece dönebilen yüksek drenaj kapasiteli koku fermatürlü S sifon, saç tutucu, 20 cm genişliğinde bütül bant, uygulama sonrası oluşabilecek kot farklılıklarını önleyen yükseklik ayar setini uygulama kolaylığı sağlayacak şekilde standardize ederek, tek parça ürün olarak birleştiriyor ve kullanıcılara kolay montaj avantajı sunuyor.

EBAT Size	Inox Satinox	Satine Altın Satin Gold	Satine Bakır Satin Bronze	Siyah Black
40 cm	DF 040 01 10 S01	DF 040 21 10 S01	DF 040 31 10 S01	DF 040 55 10 S01
50 cm	DF 050 01 10 S01	DF 050 21 10 S01	DF 050 31 10 S01	DF 050 55 10 S01
60 cm	DF 060 01 10 S01	DF 060 21 10 S01	DF 060 31 10 S01	DF 060 55 10 S01
70 cm	DF 070 01 10 S01	DF 070 21 10 S01	DF 070 31 10 S01	DF 070 55 10 S01
80 cm	DF 080 01 10 S01	DF 080 21 10 S01	DF 080 31 10 S01	DF 080 55 10 S01
90 cm	DF 090 01 10 S01	DF 090 21 10 S01	DF 090 31 10 S01	DF 090 55 10 S01
100 cm	DF 100 01 10 S01	DF 100 21 10 S01	DF 100 31 10 S01	DF 100 55 10 S01
120 cm	DF 120 01 10 S01	DF 120 21 10 S01	DF 120 31 10 S01	DF 120 55 10 S01

EBAT Size	Inox Ayna Inox Mirror	Altın Ayna Gold Mirror	Bakır Ayna Bronze Mirror
40 cm	DF 040 01 10 S01	DF 040 20 10 S01	DF 040 30 10 S01
50 cm	DF 050 00 10 S01	DF 050 20 10 S01	DF 050 30 10 S01
60 cm	DF 060 00 10 S01	DF 060 20 10 S01	DF 060 30 10 S01
70 cm	DF 070 00 10 S01	DF 070 20 10 S01	DF 070 30 10 S01
80 cm	DF 080 00 10 S01	DF 080 20 10 S01	DF 080 30 10 S01
90 cm	DF 090 00 10 S01	DF 090 20 10 S01	DF 090 30 10 S01
100 cm	DF 100 00 10 S01	DF 100 20 10 S01	DF 100 30 10 S01
120 cm	DF 120 00 10 S01	DF 120 20 10 S01	DF 120 30 10 S01



Size uygun sifon tipini siparişiniz esnasında ürün koduna ekleyiniz.
Please add the siphon type to the product code in your order.

S01

h : 60 mm
Debi: 42 lt/dk - Flow: 42 lt/min
Kokusuz / Odor free



S08

h : 30/80 mm
Karat: 110 mm - Care Drill Diameter ø: 110 mm
Debi : 48 lt/dk - Flow: 48 lt/dk
Kokusuz / Odor free



S09

h : 60 mm
Debi: 51 lt/dk - Flow: 51 lt/min
Kokusuz / Odor free



S13

h : 60 mm
Karat: 110 mm - Care Drill Diameter ø: 110 mm
Debi: 48 lt/dk - Flow: 48 lt/min
Kokusuz / Odor free



S15

h : 60 mm
Debi: 42 lt/dk - Flow: 42 lt/min
Kokusuz / Odor free



S16

h : 80 mm
Debi: 60 lt/dk - Flow: 60 lt/min
Kokusuz / Odor free



S17

h : 80 mm
Debi: 60 lt/dk - Flow: 60 lt/min
Kokusuz / Odor free



S18

h : 60 mm
Debi: 42 lt/dk - Flow: 42 lt/min
Kokusuz / Odor free



S50/S95

Sifonsuz Direkt Bağlantı
(Direct Connection Without Siphon)
S50 for 2 inc (50 mm)
S95 for 4 inc (90 mm-110 mm)











PH BASIC

İzolasyonun beton üzerinde yapıldığı uygulamalarda kullanılır. Şap üzerinde izolasyon uyum özelliği bulunmamaktadır.

Used application on concrete made insulation there are not insulation skirt.

Koku tutucu özellik, kolay temizlenebilir.
Prevent odor system, easy clean.

 360° base rotation	 60 mm	 Ø50 output	 304 stainless steel
 + easy to clean	 odor prevent system	 51l/min	 easy assembling

Uygulama Kesit :

1. Döşeme Betonu / Covering Concrete
2. Tesviye Betonu / Levelling Concrete
3. Ph Dizayn Butil Bant / Ph Design Butil Bant
4. İzolasyon Katmanı / Insulation Layer
5. Yapıştırıcı / Adhesive
6. Kaplama Malzemesi / Covering

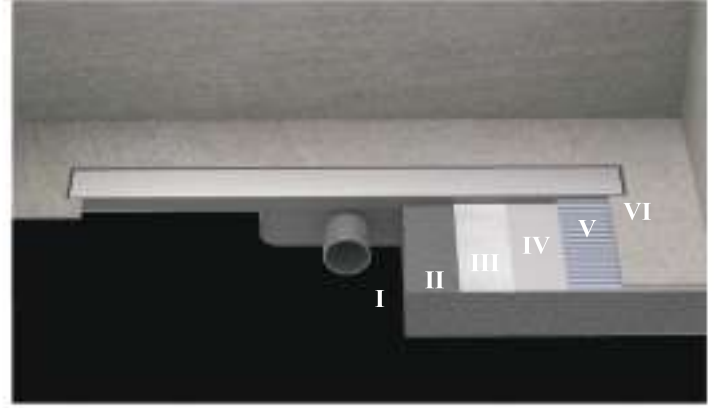

Sifon Tipi : S07

Kapak (1.5 mm kalınlık) / Top cover (1.5 mm)

Saç Tutucu Süzgeç / Hair Holder

ABS Ana Gövde + S Sifon / ABS Main Body + S Siphon

Yükseklik Ayar Parçası / Height Adjustment Kit



	30	40	50	60	70	80	90
A	30	40	50	60	70	80	90
B	29	39	49	59	69	79	89
C	5.2	5.2	5.2	5.2	5.2	5.2	5.2
D	6.5	6.5	6.5	6.5	6.5	6.5	6.5
E	5.4	5.4	5.4	5.4	5.4	5.4	5.4
F	2	2	2	2	2	2	2
G	5	5	5	5	5	5	5
H	19	19	19	19	19	19	19
I	0.5	0.5	0.5	0.5	0.5	0.5	0.5
J	7.3	7.3	7.3	7.3	7.3	7.3	7.3



EBAT Size	Inox / Linear Satinox	
30 cm	DB 030 01 00 S07	45 \$
40 cm	DB 040 01 00 S07	50 \$
50 cm	DB 050 01 00 S07	55 \$
60 cm	DB 060 01 00 S07	65 \$
70 cm	DB 070 01 00 S07	70 \$
80 cm	DB 080 01 00 S07	75 \$
90 cm	DB 090 01 00 S07	80 \$



Sifon Tipi : S47

EBAT Size	Inox / Greek Satinox	
30 cm	DB 030 01 01 S07	45 \$
40 cm	DB 040 01 01 S07	50 \$
50 cm	DB 050 01 01 S07	55 \$
60 cm	DB 060 01 01 S07	65 \$
70 cm	DB 070 01 01 S07	70 \$
80 cm	DB 080 01 01 S07	75 \$
90 cm	DB 090 01 01 S07	80 \$



Sifon Tipi : S07



Ph Standart yer süzgeçleri özel tasarlanan koku önleyici sistem ile ıslak mekanlara özel çözümler sağlamaktadır.

Ph Standart drains give special solutions for your bathrooms with its design. With its insulation skirt and odor sealing properties meet the technical expectations.

EBAT Size	Inox Satinox		Inox Ayna Inox Mirror	
10 x 10 cm Ø : 32	PD0100118S06	12 \$	PD0100018S06	15 \$
10 x 10 cm Ø : 50	PD0100118S12	20 \$	PD0100018S12	25 \$









PH SMART

PH Smart yer süzgeçleri farklı kapak ve renk alternatifleri ile ıslak mekanlar için fonksiyonel çözümler sunar.

PH Smart floor drains provide functional solutions for your bathroom with different top cover design and with different color options .

Yalıtım flanşlı sifon, koku önleyici sistemi ile su sızdırmazlık garantisi sağlar.

Siphon has insulation skirt and has prevent odor systems provide water proofing warranty.

SMART

DRAINLINE

Ph Dizayn

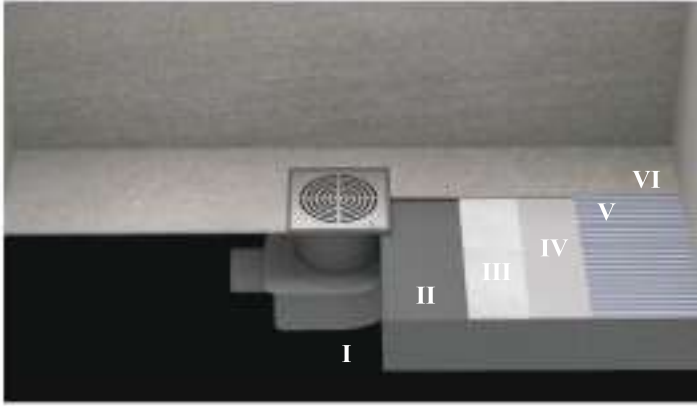

Uygulama Kesit :

1. Döşeme Betonu / Covering Concrete
2. Tesviye Betonu / Levelling Concrete
3. Ph Dizayn Butil Bant / Ph Design Butil Bant
4. İzolasyon Katmanı / Insulation Layer
5. Yapıştırıcı / Adhesive
6. Kaplama Malzemesi / Covering

Sifon Tipi : S04-S05



Kapak (1.5 mm kalınlık) / Top cover (1.5 mm)

Saç Tutucu Süzgeç / Hair Holder

Koku Önleyici / Prevent Odor System

Yükseklik Ayar Çerçevesi / Final Height Adjustment Frame

Yalıtım Flanşı / Insulating Flange

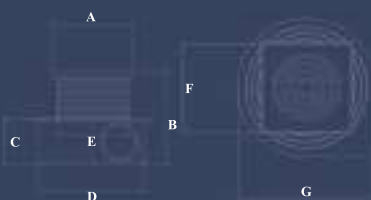

S04

	10	15
A	10	15
B	AYARLANABİLİR YÜKSEKLİK	AYARLANABİLİR YÜKSEKLİK
C	6	6
D	14	14
E	9,6	9,6
F	10	15
G	16	16

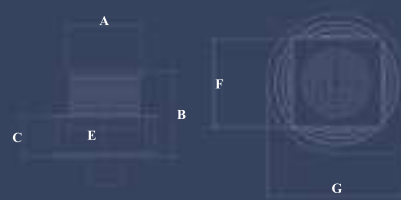

S05

	10	15
A	10	15
B	AYARLANABİLİR YÜKSEKLİK	AYARLANABİLİR YÜKSEKLİK
C	6	6
D	14	14
E	9,6	9,6
F	10	15
G	16	16

Uygulama Kesit :

1. Döşeme Betonu / Covering Concrete
2. Tesviye Betonu / Levelling Concrete
3. Ph Dizayn Butil Bant / Ph Design Butil Bant
4. İzolasyon Katmanı / Insulation Layer
5. Yapıştırıcı / Adhesive
6. Kaplama Malzemesi / Covering

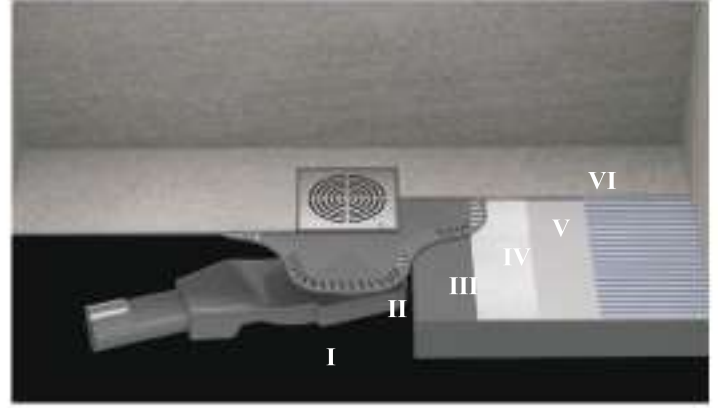

Sifon Tipi : S08-S09

Kapak (1.5 mm kalınlık) / Top cover (1.5 mm)

Saç Tutucu Süzgeç / Hair Holder

Koku Önleyici / Prevent Odor System

Yükseklik Ayar Çerçevesi / Final Height Adjustment Frame

Yalıtım Flanşı / Insulating Flange

S Sifon / S Siphon

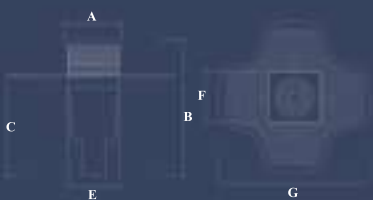
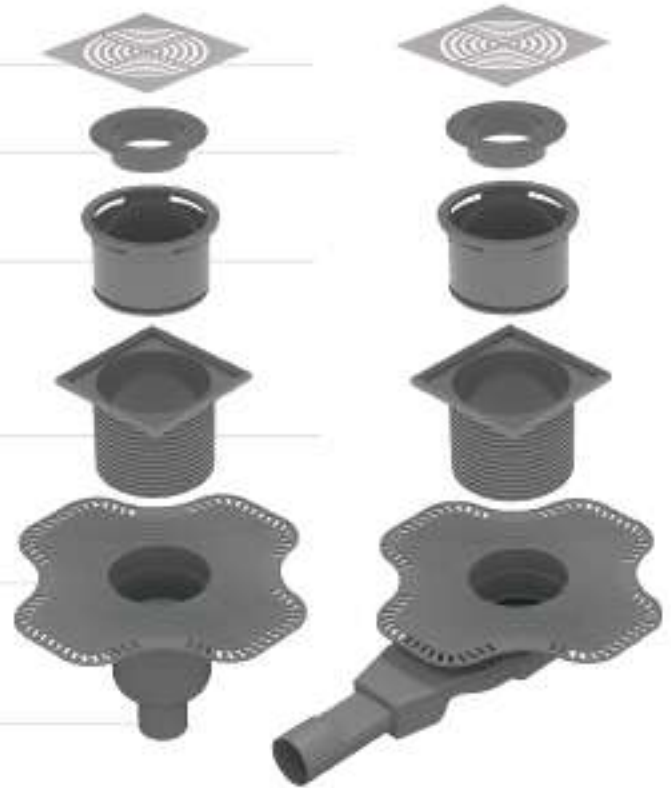

S08

	10	15
A	10	15
B	AYARLANABİLİR YÜKSEKLİK	AYARLANABİLİR YÜKSEKLİK
C	18	18
E	9,6	9,6
F	10	15
G	30	30



S09

	10	15
A	10	15
B	AYARLANABİLİR YÜKSEKLİK	AYARLANABİLİR YÜKSEKLİK
C	6	6
D	11	11
E	9,6	9,6
F	10	15
G	30	30



EBAT Size	Inox Satinox		Satine Altın Satin Gold		Satine Bakır Satin Bronze			
10x10 cm / S04	DS 010 01 D1 S04	30 \$	10x10 cm / S04	DS 010 21 D1 S04	50 \$	10x10 cm / S04	DS 010 31 D1 S04	65 \$
10x10 cm / S05	DS 010 01 D1 S05	30 \$	10x10 cm / S05	DS 010 21 D1 S05	50 \$	10x10 cm / S05	DS 010 31 D1 S05	65 \$
10x10 cm / S08	DS 010 01 D1 S08	55 \$	10x10 cm / S08	DS 010 21 D1 S08	75 \$	10x10 cm / S08	DS 010 31 D1 S08	90 \$
10x10 cm / S09	DS 010 01 D1 S09	55 \$	10x10 cm / S09	DS 010 21 D1 S09	75 \$	10x10 cm / S09	DS 010 31 D1 S09	90 \$
10x10 cm / S95	DS 010 01 D1 S95	28 \$	10x10 cm / S95	DS 010 21 D1 S95	48 \$	10x10 cm / S95	DS 010 31 D1 S95	63 \$
15x15 cm / S04	DS 015 01 D1 S04	45 \$	15x15 cm / S04	DS 015 21 D1 S04	70 \$	15x15 cm / S04	DS 015 31 D1 S04	89 \$
15x15 cm / S05	DS 015 01 D1 S05	45 \$	15x15 cm / S05	DS 015 21 D1 S05	70 \$	15x15 cm / S05	DS 015 31 D1 S05	89 \$
15x15 cm / S08	DS 015 01 D1 S08	70 \$	15x15 cm / S08	DS 015 21 D1 S08	95 \$	15x15 cm / S08	DS 015 31 D1 S08	114 \$
15x15 cm / S09	DS 015 01 D1 S09	70 \$	15x15 cm / S09	DS 015 21 D1 S09	95 \$	15x15 cm / S09	DS 015 31 D1 S09	114 \$
15x15 cm / S95	DS 015 01 D1 S95	43 \$	15x15 cm / S95	DS 015 21 D1 S95	68 \$	15x15 cm / S95	DS 015 31 D1 S95	87 \$

	Inox Ayna Inox Mirror		Altın Ayna Gold Mirror		Bakır Ayna Bronze Mirror			
10x10 cm / S04	DS 010 00 D1 S04	42 \$	10x10 cm / S04	DS 010 20 D1 S04	50 \$	10x10 cm / S04	DS 010 30 D1 S04	65 \$
10x10 cm / S05	DS 010 00 D1 S05	42 \$	10x10 cm / S05	DS 010 20 D1 S05	50 \$	10x10 cm / S05	DS 010 30 D1 S05	65 \$
10x10 cm / S08	DS 010 00 D1 S08	65 \$	10x10 cm / S08	DS 010 20 D1 S08	75 \$	10x10 cm / S08	DS 010 30 D1 S08	90 \$
10x10 cm / S09	DS 010 00 D1 S09	65 \$	10x10 cm / S09	DS 010 20 D1 S09	75 \$	10x10 cm / S09	DS 010 30 D1 S09	90 \$
10x10 cm / S95	DS 010 00 D1 S95	38 \$	10x10 cm / S95	DS 010 20 D1 S95	48 \$	10x10 cm / S95	DS 010 30 D1 S95	63 \$
15x15 cm / S04	DS 015 00 D1 S04	55 \$	15x15 cm / S04	DS 015 20 D1 S04	70 \$	15x15 cm / S04	DS 015 30 D1 S04	89 \$
15x15 cm / S05	DS 015 00 D1 S05	55 \$	15x15 cm / S05	DS 015 20 D1 S05	70 \$	15x15 cm / S05	DS 015 30 D1 S05	89 \$
15x15 cm / S08	DS 015 00 D1 S08	85 \$	15x15 cm / S08	DS 015 20 D1 S08	95 \$	15x15 cm / S08	DS 015 30 D1 S08	114 \$
15x15 cm / S09	DS 015 00 D1 S09	85 \$	15x15 cm / S09	DS 015 20 D1 S09	95 \$	15x15 cm / S09	DS 015 30 D1 S09	114 \$
15x15 cm / S95	DS 015 00 D1 S95	58 \$	15x15 cm / S95	DS 015 20 D1 S95	68 \$	15x15 cm / S95	DS 015 30 D1 S95	87 \$

	Siyah Black	
10x10 cm / S04	DS 010 55 D1 S04	50 \$
10x10 cm / S05	DS 010 55 D1 S05	50 \$
10x10 cm / S08	DS 010 55 D1 S08	75 \$
10x10 cm / S09	DS 010 55 D1 S09	75 \$
10x10 cm / S95	DS 010 55 D1 S95	48 \$
15x15 cm / S04	DS 015 55 D1 S04	70 \$
15x15 cm / S05	DS 015 55 D1 S05	70 \$
15x15 cm / S08	DS 015 55 D1 S08	95 \$
15x15 cm / S09	DS 015 55 D1 S09	95 \$
15x15 cm / S95	DS 015 55 D1 S95	68 \$



S04



S05



S08



S09



S95

Size uygun sifon tipini siparişiniz esnasında ürün koduna ekleyiniz.
Please add the siphon type to the product code in your order.



EBAT Size	Inox Satinox	
10x10 cm / S04	DS 010 01 D2 S04	30 \$
10x10 cm / S05	DS 010 01 D2 S05	30 \$
10x10 cm / S08	DS 010 01 D2 S08	55 \$
10x10 cm / S09	DS 010 01 D2 S09	55 \$
10x10 cm / S95	DS 010 01 D2 S95	28 \$
15x15 cm / S04	DS 015 01 D2 S04	45 \$
15x15 cm / S05	DS 015 01 D2 S05	45 \$
15x15 cm / S08	DS 015 01 D2 S08	70 \$
15x15 cm / S09	DS 015 01 D2 S09	70 \$
15x15 cm / S95	DS 015 01 D2 S95	43 \$

	Satine Altın Satin Gold	
10x10 cm / S04	DS 010 21 D2 S04	50 \$
10x10 cm / S05	DS 010 21 D2 S05	50 \$
10x10 cm / S08	DS 010 21 D2 S08	75 \$
10x10 cm / S09	DS 010 21 D2 S09	75 \$
10x10 cm / S95	DS 010 21 D2 S95	48 \$
15x15 cm / S04	DS 015 21 D2 S04	70 \$
15x15 cm / S05	DS 015 21 D2 S05	70 \$
15x15 cm / S08	DS 015 21 D2 S08	95 \$
15x15 cm / S09	DS 015 21 D2 S09	95 \$
15x15 cm / S95	DS 015 21 D2 S95	68 \$

	Satine Bakır Satin Bronze	
10x10 cm / S04	DS 010 31 D2 S04	65 \$
10x10 cm / S05	DS 010 31 D2 S05	65 \$
10x10 cm / S08	DS 010 31 D2 S08	90 \$
10x10 cm / S09	DS 010 31 D2 S09	90 \$
10x10 cm / S95	DS 010 31 D2 S95	63 \$
15x15 cm / S04	DS 015 31 D2 S04	89 \$
15x15 cm / S05	DS 015 31 D2 S05	89 \$
15x15 cm / S08	DS 015 31 D2 S08	114 \$
15x15 cm / S09	DS 015 31 D2 S09	114 \$
15x15 cm / S95	DS 015 31 D2 S95	87 \$

	Inox Ayna Inox Mirror	
10x10 cm / S04	DS 010 00 D2 S04	42 \$
10x10 cm / S05	DS 010 00 D2 S05	42 \$
10x10 cm / S08	DS 010 00 D2 S08	65 \$
10x10 cm / S09	DS 010 00 D2 S09	65 \$
10x10 cm / S95	DS 010 00 D2 S95	38 \$
15x15 cm / S04	DS 015 00 D2 S04	55 \$
15x15 cm / S05	DS 015 00 D2 S05	55 \$
15x15 cm / S08	DS 015 00 D2 S08	85 \$
15x15 cm / S09	DS 015 00 D2 S09	85 \$
15x15 cm / S95	DS 015 00 D2 S95	58 \$

	Altın Ayna Gold Mirror	
10x10 cm / S04	DS 010 20 D2 S04	50 \$
10x10 cm / S05	DS 010 20 D2 S05	50 \$
10x10 cm / S08	DS 010 20 D2 S08	75 \$
10x10 cm / S09	DS 010 20 D2 S09	75 \$
10x10 cm / S95	DS 010 20 D2 S09	48 \$
15x15 cm / S04	DS 015 20 D2 S04	70 \$
15x15 cm / S05	DS 015 20 D2 S05	70 \$
15x15 cm / S08	DS 015 20 D2 S08	95 \$
15x15 cm / S09	DS 015 20 D2 S09	95 \$
15x15 cm / S95	DS 015 20 D2 S95	68 \$

	Bakır Ayna Bronze Mirror	
10x10 cm / S04	DS 010 30 D2 S04	65 \$
10x10 cm / S05	DS 010 30 D2 S05	65 \$
10x10 cm / S08	DS 010 30 D2 S08	90 \$
10x10 cm / S09	DS 010 30 D2 S09	90 \$
10x10 cm / S95	DS 010 30 D2 S95	63 \$
15x15 cm / S04	DS 015 30 D2 S04	89 \$
15x15 cm / S05	DS 015 30 D2 S05	89 \$
15x15 cm / S08	DS 015 30 D2 S08	114 \$
15x15 cm / S09	DS 015 30 D2 S09	114 \$
15x15 cm / S95	DS 015 30 D2 S95	87 \$

	Siyah Black	
10x10 cm / S04	DS 010 55 D2 S04	50 \$
10x10 cm / S05	DS 010 55 D2 S05	50 \$
10x10 cm / S08	DS 010 55 D2 S08	75 \$
10x10 cm / S09	DS 010 55 D2 S09	75 \$
10x10 cm / S95	DS 010 55 D2 S95	48 \$
15x15 cm / S04	DS 015 55 D2 S04	70 \$
15x15 cm / S05	DS 015 55 D2 S05	70 \$
15x15 cm / S08	DS 015 55 D2 S08	95 \$
15x15 cm / S09	DS 015 55 D2 S09	95 \$
15x15 cm / S95	DS 015 55 D2 S95	68 \$



S04



S05



S08



S09



S95



EBAT Size	Inox Satinox	
10x10 cm / S04	DS 010 01 D3 S04	30 \$
10x10 cm / S05	DS 010 01 D3 S05	30 \$
10x10 cm / S08	DS 010 01 D3 S08	55 \$
10x10 cm / S09	DS 010 01 D3 S09	55 \$
10x10 cm / S95	DS 010 01 D3 S95	28 \$
15x15 cm / S04	DS 015 01 D3 S04	45 \$
15x15 cm / S05	DS 015 01 D3 S05	45 \$
15x15 cm / S08	DS 015 01 D3 S08	70 \$
15x15 cm / S09	DS 015 01 D3 S09	70 \$
15x15 cm / S95	DS 015 01 D3 S95	43 \$

	Satine Altın Satin Gold	
10x10 cm / S04	DS 010 21 D3 S04	50 \$
10x10 cm / S05	DS 010 21 D3 S05	50 \$
10x10 cm / S08	DS 010 21 D3 S08	75 \$
10x10 cm / S09	DS 010 21 D3 S09	75 \$
10x10 cm / S95	DS 010 21 D3 S95	48 \$
15x15 cm / S04	DS 015 21 D3 S04	70 \$
15x15 cm / S05	DS 015 21 D3 S05	70 \$
15x15 cm / S08	DS 015 21 D3 S08	95 \$
15x15 cm / S09	DS 015 21 D3 S09	95 \$
15x15 cm / S95	DS 015 21 D3 S95	68 \$

	Satine Bakır Satin Bronze	
10x10 cm / S04	DS 010 31 D3 S04	65 \$
10x10 cm / S05	DS 010 31 D3 S05	65 \$
10x10 cm / S08	DS 010 31 D3 S08	90 \$
10x10 cm / S09	DS 010 31 D3 S09	90 \$
10x10 cm / S95	DS 010 31 D3 S95	63 \$
15x15 cm / S04	DS 015 31 D3 S04	89 \$
15x15 cm / S05	DS 015 31 D3 S05	89 \$
15x15 cm / S08	DS 015 31 D3 S08	114 \$
15x15 cm / S09	DS 015 31 D3 S09	114 \$
15x15 cm / S95	DS 015 31 D3 S95	87 \$

	Inox Ayna Inox Mirror	
10x10 cm / S04	DS 010 00 D3 S04	42 \$
10x10 cm / S05	DS 010 00 D3 S05	42 \$
10x10 cm / S08	DS 010 00 D3 S08	65 \$
10x10 cm / S09	DS 010 00 D3 S09	65 \$
10x10 cm / S95	DS 010 00 D3 S95	38 \$
15x15 cm / S04	DS 015 00 D3 S04	55 \$
15x15 cm / S05	DS 015 00 D3 S05	55 \$
15x15 cm / S08	DS 015 00 D3 S08	85 \$
15x15 cm / S09	DS 015 00 D3 S09	85 \$
15x15 cm / S95	DS 015 00 D3 S95	58 \$

	Altın Ayna Gold Mirror	
10x10 cm / S04	DS 010 20 D3 S04	50 \$
10x10 cm / S05	DS 010 20 D3 S05	50 \$
10x10 cm / S08	DS 010 20 D3 S08	75 \$
10x10 cm / S09	DS 010 20 D3 S09	75 \$
10x10 cm / S95	DS 010 20 D3 S95	48 \$
15x15 cm / S04	DS 015 20 D3 S04	70 \$
15x15 cm / S05	DS 015 20 D3 S05	70 \$
15x15 cm / S08	DS 015 20 D3 S08	95 \$
15x15 cm / S09	DS 015 20 D3 S09	95 \$
15x15 cm / S95	DS 015 20 D3 S95	68 \$

	Bakır Ayna Bronze Mirror	
10x10 cm / S04	DS 010 30 D3 S04	65 \$
10x10 cm / S05	DS 010 30 D3 S05	65 \$
10x10 cm / S08	DS 010 30 D3 S08	90 \$
10x10 cm / S09	DS 010 30 D3 S09	90 \$
10x10 cm / S95	DS 010 30 D3 S95	63 \$
15x15 cm / S04	DS 015 30 D3 S04	89 \$
15x15 cm / S05	DS 015 30 D3 S05	89 \$
15x15 cm / S08	DS 015 30 D3 S08	114 \$
15x15 cm / S09	DS 015 30 D3 S09	114 \$
15x15 cm / S95	DS 015 30 D3 S95	87 \$

	Siyah Black	
10x10 cm / S04	DS 010 55 D3 S04	50 \$
10x10 cm / S05	DS 010 55 D3 S05	50 \$
10x10 cm / S08	DS 010 55 D3 S08	75 \$
10x10 cm / S09	DS 010 55 D3 S09	75 \$
10x10 cm / S95	DS 010 55 D3 S95	48 \$
15x15 cm / S04	DS 015 55 D3 S04	70 \$
15x15 cm / S05	DS 015 55 D3 S05	70 \$
15x15 cm / S08	DS 015 55 D3 S08	95 \$
15x15 cm / S09	DS 015 55 D3 S09	95 \$
15x15 cm / S95	DS 015 55 D3 S95	68 \$



S04



S05



S08



S09



S95

Size uygun sifon tipini siparişiniz esnasında ürün koduna ekleyiniz.
Please add the siphon type to the product code in your order.



EBAT Size	Inox Satinox	
10x10 cm / S04	DS 010 01 D4 S04	30 \$
10x10 cm / S05	DS 010 01 D4 S05	30 \$
10x10 cm / S08	DS 010 01 D4 S08	55 \$
10x10 cm / S09	DS 010 01 D4 S09	55 \$
10x10 cm / S95	DS 010 01 D4 S95	28 \$
15x15 cm / S04	DS 015 01 D4 S04	45 \$
15x15 cm / S05	DS 015 01 D4 S05	45 \$
15x15 cm / S08	DS 015 01 D4 S08	70 \$
15x15 cm / S09	DS 015 01 D4 S09	70 \$
15x15 cm / S95	DS 015 01 D4 S95	43 \$

	Satine Altın Satin Gold	
10x10 cm / S04	DS 010 21 D4 S04	50 \$
10x10 cm / S05	DS 010 21 D4 S05	50 \$
10x10 cm / S08	DS 010 21 D4 S08	75 \$
10x10 cm / S09	DS 010 21 D4 S09	75 \$
10x10 cm / S95	DS 010 21 D4 S95	48 \$
15x15 cm / S04	DS 015 21 D4 S04	70 \$
15x15 cm / S05	DS 015 21 D4 S05	70 \$
15x15 cm / S08	DS 015 21 D4 S08	95 \$
15x15 cm / S09	DS 015 21 D4 S09	95 \$
15x15 cm / S95	DS 015 21 D4 S95	68 \$

	Satine Bakır Satin Bronze	
10x10 cm / S04	DS 010 31 D4 S04	65 \$
10x10 cm / S05	DS 010 31 D4 S05	65 \$
10x10 cm / S08	DS 010 31 D4 S08	90 \$
10x10 cm / S09	DS 010 31 D4 S09	90 \$
10x10 cm / S95	DS 010 31 D4 S95	63 \$
15x15 cm / S04	DS 015 31 D4 S04	89 \$
15x15 cm / S05	DS 015 31 D4 S05	89 \$
15x15 cm / S08	DS 015 31 D4 S08	114 \$
15x15 cm / S09	DS 015 31 D4 S09	114 \$
15x15 cm / S95	DS 015 31 D4 S95	87 \$

	Inox Ayna Inox Mirror	
10x10 cm / S04	DS 010 00 D4 S04	42 \$
10x10 cm / S05	DS 010 00 D4 S05	42 \$
10x10 cm / S08	DS 010 00 D4 S08	65 \$
10x10 cm / S09	DS 010 00 D4 S09	65 \$
10x10 cm / S95	DS 010 00 D4 S95	38 \$
15x15 cm / S04	DS 015 00 D4 S04	55 \$
15x15 cm / S05	DS 015 00 D4 S05	55 \$
15x15 cm / S08	DS 015 00 D4 S08	85 \$
15x15 cm / S09	DS 015 00 D4 S09	85 \$
15x15 cm / S95	DS 015 00 D4 S95	58 \$

	Altın Ayna Gold Mirror	
10x10 cm / S04	DS 010 20 D4 S04	50 \$
10x10 cm / S05	DS 010 20 D4 S05	50 \$
10x10 cm / S08	DS 010 20 D4 S08	75 \$
10x10 cm / S09	DS 010 20 D4 S09	75 \$
10x10 cm / S95	DS 010 20 D4 S95	48 \$
15x15 cm / S04	DS 015 20 D4 S04	70 \$
15x15 cm / S05	DS 015 20 D4 S05	70 \$
15x15 cm / S08	DS 015 20 D4 S08	95 \$
15x15 cm / S09	DS 015 20 D4 S09	95 \$
15x15 cm / S95	DS 015 20 D4 S95	68 \$

	Bakır Ayna Bronze Mirror	
10x10 cm / S04	DS 010 30 D4 S04	65 \$
10x10 cm / S05	DS 010 30 D4 S05	65 \$
10x10 cm / S08	DS 010 30 D4 S08	90 \$
10x10 cm / S09	DS 010 30 D4 S09	90 \$
10x10 cm / S95	DS 010 30 D4 S95	63 \$
15x15 cm / S04	DS 015 30 D4 S04	89 \$
15x15 cm / S05	DS 015 30 D4 S05	89 \$
15x15 cm / S08	DS 015 30 D4 S08	114 \$
15x15 cm / S09	DS 015 30 D4 S09	114 \$
15x15 cm / S95	DS 015 30 D4 S95	87 \$

	Siyah Black	
10x10 cm / S04	DS 010 55 D4 S04	50 \$
10x10 cm / S05	DS 010 55 D4 S05	50 \$
10x10 cm / S08	DS 010 55 D4 S08	75 \$
10x10 cm / S09	DS 010 55 D4 S09	75 \$
10x10 cm / S95	DS 010 55 D4 S95	48 \$
15x15 cm / S04	DS 015 55 D4 S04	70 \$
15x15 cm / S05	DS 015 55 D4 S05	70 \$
15x15 cm / S08	DS 015 55 D4 S08	95 \$
15x15 cm / S09	DS 015 55 D4 S09	95 \$
15x15 cm / S95	DS 015 55 D4 S95	68 \$



S04



S05



S08



S09



S95



EBAT Size	Inox Satinox	
10x10 cm / S04	DS 010 01 D5 S04	50 \$
10x10 cm / S05	DS 010 01 D5 S05	50 \$
10x10 cm / S08	DS 010 01 D5 S08	75 \$
10x10 cm / S09	DS 010 01 D5 S09	75 \$
10x10 cm / S95	DS 010 01 D5 S95	48 \$
15x15 cm / S04	DS 015 01 D5 S04	60 \$
15x15 cm / S05	DS 015 01 D5 S05	60 \$
15x15 cm / S08	DS 015 01 D5 S08	85 \$
15x15 cm / S09	DS 015 01 D5 S09	85 \$
15x15 cm / S95	DS 015 01 D5 S95	58 \$

	Inox Satinox	
10x10 cm / S04	DS 010 01 D6 S04	45 \$
10x10 cm / S05	DS 010 01 D6 S05	45 \$
10x10 cm / S08	DS 010 01 D6 S08	70 \$
10x10 cm / S09	DS 010 01 D6 S09	70 \$
10x10 cm / S95	DS 010 01 D6 S95	43 \$
15x15 cm / S04	DS 015 01 D6 S04	55 \$
15x15 cm / S05	DS 015 01 D6 S05	55 \$
15x15 cm / S08	DS 015 01 D6 S08	80 \$
15x15 cm / S09	DS 015 01 D6 S09	80 \$
15x15 cm / S95	DS 015 01 D6 S95	53 \$



S04



S05



S08



S09



S95

YARDIMCI MEYİL PROFİLLERİ SLOPE PROFILES

Duř kanalları kullanılan alanlarda bitiři saęlamak amacıyla kullanılan paslanmaz elik eęim profilidir. Yıkama alanıyla banyo alanının kot farklılıęı iin temiz bitiř saęlar.



EęİMLİ PROFİL (13 mm-28 mm)

SLOPE PROFILE

	SAę 100 cm Right		SOL 100 cm Left	
Inox/Satinox	PEP100R01	32,5 \$	PEP100L01	32,5 \$
Inox Ayna/Mirror	PEP100R00	41,6 \$	PEP100L00	41,6 \$
Altın Ayna/Gold	PEP100R20	49,4 \$	PEP100L20	49,4 \$
	SAę 150 cm Right		SOL 150 cm Left	
Inox/Satinox	PEP150R01	41,6 \$	PEP150L01	41,6 \$
Inox Ayna/Mirror	PEP150R00	52,0 \$	PEP150L00	52,0 \$
Altın Ayna/Gold	PEP150R20	62,4 \$	PEP150L20	62,4 \$



EęİMSİZ PROFİL (28 mm)

FLAT PROFILE

	250 cm	
Inox/Satinox	EPP25001	75,40 \$
Inox Ayna/Mirror	EPP25000	96,20 \$
Altın Ayna/Gold	EPP25020	111,8 \$



DUř KABİN CAM PROFİLİ SHOWER ENCLOSURE GLASS PROFILE

EBAT Size	Inox Satinox		Inox Parlak Shine	
8 mm / 10 mm	PC100825001	43,5 \$	PC100825003	43,5 \$
10 mm / 10 mm	PC101025001	44,0 \$	PC101025003	44,0 \$
12 mm / 10 mm	PC101225001	44,5 \$	PC101225003	44,5 \$
8 mm / 13 mm	PC130825001	43,5 \$	PC130825003	43,5 \$
10 mm / 13 mm	PC131025001	44,0 \$	PC131025003	44,0 \$
12 mm / 13 mm	PC131225001	44,5 \$	PC131225003	44,5 \$

BÜTİL BANT

BUTIL BAND

PBT020011	20 cm linear süzge bütıl bant (sızdırmaz)	14,3 \$/m
PBT040011	40 x 40 cm bütıl bant (sızdırmaz)	20,8 \$/adet

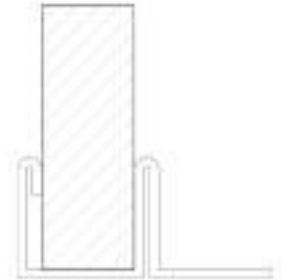

Paslanma Çelik Teknik Profil

Technoline serisi teknik profiller yüksek dayanıklılığa sahip 304 kalite paslanmaz çelikten üretilmektedir. Technoline paslanmaz çelik teknik profiller mukavemetinin oldukça yüksek olması, renk alternatiflerinin geniş olması ve renklerinin pvd kaplama ile oluşturulması sonucu derz dolgu malzemelerinden etkilenmemesi özelliği ile alternatiflerine (plastik ve alüminyum) oranla tercih sebebi olmaktadır. Technoline ürünler 10 farklı renk seçeneği sunmaktadır.

TECHNOLINE

Stainless Steel Technical Profile

TECHNICAL PROFILES are produced 304 quality 1st stainless steel. Stainless steel profiles create lighting or opaque effects to define and delineate different spaces and through their various heights, from 8mm, 10mm, 12mm, 14mm they can be combined with all types of tiles. Technoline creates unusual combinations and contrasts with endless variations of materials, different colour and finishes. Technoline are designed to provide a long-lasting finish and corrosion resistance to ceramic and floor tiles. Technical profiles are covered with a special protection film for easy application. Offered 10 different surface options and lengths are 244 cm and 250 cm.

304

stainless
steel

51l/min



easy
to clean



odor prevent
system



360°
base
rotation



60
mm



Ø50
output



easy
assembling

PROFIX KD

DÜŞÜK KOT PROFİLİ

TECHNOLINE

P Dizayn



Ebat Size	Inox Satinox	
20/8 mm	PKD200825001	30,0 \$
20/10 mm	PKD201025001	30,2 \$
20/12 mm	PKD201225001	30,4 \$
20/14 mm	PKD201425001	30,8 \$

Ebat Size	Inox Satinox	
25/8 mm	PKD250825001	35,0 \$
25/10 mm	PKD251025001	35,2 \$
25/12 mm	PKD251225001	35,4 \$
25/14 mm	PKD251425001	35,8 \$

Ebat Size	Inox Satinox	
30/8 mm	PKD300825001	45,0 \$
30/10 mm	PKD301025001	45,2 \$
30/12 mm	PKD301225001	45,4 \$
30/14 mm	PKD301425001	45,8 \$

Profix KD, duş alanlarında kullanılan paslanmaz çelikten üretilen düşük kot profilidir.

Profix KD is low level profile produced from grade stainless steel.

Inox (Satinox), Dekorlu (Decor), Inox Parlak (Shine) yüzeyler 250 cm boyda üretilmektedir. / Surfaces 250 cm lenght. Ayna (Mirror), Altın (Satine Gold), Altın ayna (Gold), Bakır (Satine bronze), Bakır Ayna (Bronze mirror), Antrasit (Satine Antracite), Antrasit ayna (Antracite mirror) yüzeyler 244 cm boyda üretilmektedir. / surfaces 244 cm lenght. Maximum boy 300 cm üretilmektedir. / Profile can be produced up to 300 cm. Paket içi adeti: 6 ADET / Products per box. Belirtilen hammadde kalınlıkları 0,80 mm dir, 0,60 mm için fiyat talep edilmelidir. Thickness is 0,80 mm. Should be request price for 0,60 mm alternatives.

TEKNİK ÖLÇÜ TABLOSU

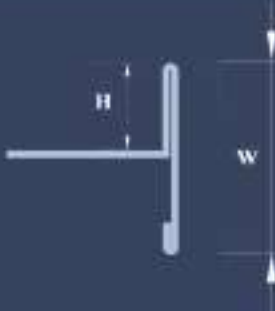

	20/8 mm	20/10 mm	20/12 mm	20/14 mm
W	20	20	20	20
H	9,5	11,5	13,5	15,5

	30/8 mm	30/10 mm	30/12 mm	30/14 mm
W	30	30	30	30
H	9,5	11,5	13,5	15,5

	205/8 mm	25/10 mm	25/12 mm	25/14 mm
W	25	25	25	25
H	9,5	11,5	13,5	15,5



Ebat size	Inox satinox	Dekorlu decor	Altın s gold	Bakır s bronze	Antrasit s. anthracite
8 mm	PF0825001	22,5 \$ PF0825011	31,0 \$ PF0824421	30,5 \$ PF0824431	42,0 \$ PF0824441
10 mm	PF1025001	23,0 \$ PF1025011	31,5 \$ PF1024421	31,0 \$ PF1024431	42,5 \$ PF1024441
12 mm	PF1225001	23,5 \$ PF1225011	32,0 \$ PF1224421	31,5 \$ PF1224431	43,0 \$ PF1224441
14 mm	PF1425001	24,0 \$ PF1425011	32,5 \$ PF1424421	32,0 \$ PF1424431	43,5 \$ PF1424441
Ebat size	Inox Ayna mirror	Inox Parlak shine	Altın Ayna gold	Bakır Ayna bronze	Antrasit Ayna anthracite
8 mm	PF0824400	26,5 \$ PF0825003	22,5 \$ PF0824420	30,5 \$ PF0824430	42,0 \$ PF0824440
10 mm	PF1024400	27,0 \$ PF1025003	23,0 \$ PF1024420	31,0 \$ PF1024430	42,5 \$ PF1024440
12 mm	PF1224400	27,5 \$ PF1225003	23,5 \$ PF1224420	31,5 \$ PF1224430	43,0 \$ PF1224440
14 mm	PF1424400	28,0 \$ PF1425003	24,0 \$ PF1424420	32,0 \$ PF1424430	43,5 \$ PF1424440

Profix F Seramik yüzeylerin dış köşelerini korumak amacıyla kullanılan dekoratif görünümlü paslanmaz çelikten üretilen dik açılı bitiş profilidir. Seramik yüzeylerin dış köşelerini korumak için 304 kalite paslanmaz çelikten üretilen dik açılı bitiş profilidir. 10 farklı renk alternatifi ile üretilmektedir. Renkli ürünler PVD teknolojisi ile paslanmaz yüzeye yüksek dayanıma sahip titanyum iyon kaplama yöntemi ile üretilmektedir. Profix F is internal outer edge protection profile produced from 4301 grade stainless steel with offered 10 different surface colour options. All colour options produced by PVD technologies with high resistance titanium covered.

Inox (Satinox), Dekorlu (Decor), Inox Parlak (Shine) yüzeyler 250 cm boyda üretilmektedir. / Surfaces 250 cm lenght. Ayna (Mirror), Altın (Satine Gold), Altın ayna (Gold), Bakır (Satine bronze), Bakır Ayna (Bronze mirror), Antrasit (Satine Anthracite), Antrasit ayna (Anthracite mirror) yüzeyler 244 cm boyda üretilmektedir. / surfaces 244 cm lenght. Maximum boy 300 cm üretilmektedir. / Profile can be produced up to 300 cm. Paket içi adeti: 6 ADET / Products per box. Belirtilen hammadde kalınlıkları 0,80 mm dir, 0,60 mm için fiyat talep edilmelidir. Thickness is 0,80 mm. Should be request price for 0,60 mm alternatives.



TEKNİK ÖLÇÜ TABLOSU

	8 mm	10 mm	12 mm	14 mm
W	5,5	5,5	5,5	5,5
H	10	12	14	16

PROFIX Q

KARE KÖŞE
KORUMA PROFİLİ

TECHNOLINE

R Dizayn



Ebat size	Inox satinox	Dekorlu decor	Altın s gold	Bakır s bronze	Antrasit s. anthracite
8 mm	PQ0825001 22,5 \$	PQ0825011 31,0 \$	PQ0824421 30,5 \$	PQ0824431 38,0 \$	PQ0824441 38,0 \$
10 mm	PQ1025001 23,0 \$	PQ1025011 31,5 \$	PQ1024421 31,0 \$	PQ1024431 38,5 \$	PQ1024441 38,5 \$
12 mm	PQ1225001 23,5 \$	PQ1225011 32,0 \$	PQ1224421 31,5 \$	PQ1224431 39,0 \$	PQ1224441 39,0 \$
14 mm	PQ1425001 24,0 \$	PQ1425011 32,5 \$	PQ1424421 32,0 \$	PQ1424431 39,5 \$	PQ1424441 39,5 \$

Ebat size	Inox Ayna mirror	Inox Parlak shine	Altın Ayna gold	Bakır Ayna bronze	Antrasit Ayna anthracite
8 mm	PQ0824400 26,5 \$	PQ0825003 22,5 \$	PQ0824420 30,5 \$	PQ0824430 38,0 \$	PQ0824440 38,0 \$
10 mm	PQ1024400 27,0 \$	PQ1025003 23,0 \$	PQ1024420 31,0 \$	PQ1024430 38,5 \$	PQ1024440 38,5 \$
12 mm	PQ1224400 27,5 \$	PQ1225003 23,5 \$	PQ1224420 31,5 \$	PQ1224430 39,0 \$	PQ1224440 39,0 \$
14 mm	PQ1424400 28,0 \$	PQ1425003 24,0 \$	PQ1424420 32,0 \$	PQ1424430 39,5 \$	PQ1424440 39,5 \$

Profix Q seramik yüzeylerin dış köşelerini korumak amacıyla kullanılan dekoratif görünümlü paslanmaz çelikten üretilen kare köşe koruma profilidir. Seramik yüzeylerin dış köşelerini korumak için 304 kalite paslanmaz çelikten üretilen kare bitiş profilidir. 10 farklı renk alternatifi ile üretilmektedir. Renkli ürünler PVD teknolojisi ile paslanmaz yüzeye yüksek dayanıma sahip titanyum iyon kaplama yöntemi ile üretilmektedir. Profix Q is square corner edge protection profile produced from 4301 grade stainless steel with offered 10 different surface colour options. All color options produced by PVD technologies with high resistance titanium ion covered.

Inox (Satinox), Dekorlu (Decor), Inox Parlak (Shine) yüzeyler 250 cm boyda üretilmektedir. / Surfaces 250 cm length. Ayna (Mirror), Altın (Satine Gold), Altın ayna (Gold), Bakır (Satine bronze), Bakır Ayna (Bronze mirror), Antrasit (Satine Anthracite), Antrasit ayna (Anthracite mirror) yüzeyler 244 cm boyda üretilmektedir. / surfaces 244 cm length. Maximum boy 300 cm üretilmektedir. / Profile can be produced up to 300 cm. Paket içi adeti: 10 ADET / Products per box. Belirtilen hammadde kalınlıkları 0,80 mm dir, 0,60 mm için fiyat talep edilmelidir. Thickness is 0,80 mm. Should be request price for 0,60 mm alternatives.

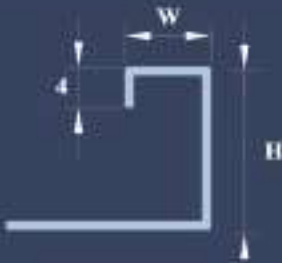

TEKNİK ÖLÇÜ TABLOSU

	8 mm	10 mm	12 mm	14 mm
W	8,5	8,5	8,5	8,5
H	10	12	14	16



Ebat size	Inox satinox	Dekorlu decor	Altın s gold	Bakır s bronze	Antrasit s. anthracite
8 mm	TQ0825001 18,6 \$	TQ0825011 24,8 \$	TQ0824421 22,1 \$	TQ0824431 25,6 \$	TQ0824441 25,6 \$
10 mm	TQ1025001 19,0 \$	TQ1025011 25,2 \$	TQ1024421 22,5 \$	TQ1024431 26,0 \$	TQ1024441 26,0 \$
12 mm	TQ1225001 19,4 \$	TQ1225011 25,6 \$	TQ1224421 22,9 \$	TQ1224431 26,4 \$	TQ1224441 26,4 \$
14 mm	TQ1425001 19,8 \$	TQ1425011 26,0 \$	TQ1424421 23,3 \$	TQ1424431 26,8 \$	TQ1424441 26,8 \$

Ebat size	Inox Ayna mirror	Inox Parlak shine	Altın Ayna gold	Bakır Ayna bronze	Antrasit Ayna anthracite
8 mm	TQ0824400 20,1 \$	TQ0825003 18,6 \$	TQ0824420 22,1 \$	TQ0824430 25,6 \$	TQ0824440 25,6 \$
10 mm	TQ1024400 20,5 \$	TQ1025003 19,0 \$	TQ1024420 22,5 \$	TQ1024430 26,0 \$	TQ1024440 26,0 \$
12 mm	TQ1224400 20,9 \$	TQ1225003 19,4 \$	TQ1224420 22,9 \$	TQ1224430 26,4 \$	TQ1224440 26,4 \$
14 mm	TQ1424400 21,3 \$	TQ1425003 19,8 \$	TQ1424420 23,3 \$	TQ1424430 26,8 \$	TQ1424440 26,8 \$

Profix QE seramik yüzeylerin dış köşelerini korumak amacıyla kullanılan dekoratif görünümlü paslanmaz çelikten üretilen kare köşe koruma profilidir. Seramik yüzeylerin dış köşelerini korumak için 304 kalite paslanmaz çelikten üretilen kare bitiş profilidir. 10 farklı renk alternatifini ile üretilmektedir. Renkli ürünler PVD teknolojisi ile paslanmaz yüzeye yüksek dayanıma sahip titanyum iyon kaplama yöntemi ile üretilmektedir. Profix Q is square corner edge protection profile produced from 4301 grade stainless steel with offered 10 different surface colour options. All color options produced by PVD technologies with high resistance titanium ion covered .

Inox (Satinox), Dekorlu (Decor), Inox Parlak (Shine) yüzeyler 250 cm boyda üretilmektedir. / Surfaces 250 cm lenght. Ayna (Mirror), Altın (Satine Gold), Altın ayna (Gold), Bakır (Satine bronze), Bakır Ayna (Bronze mirror), Antrasit (Satine Anthracite), Antrasit ayna (Anthracite mirror) yüzeyler 244 cm boyda üretilmektedir. / surfaces 244 cm lenght. Maximum boy 300 cm üretilmektedir. / Profile can be produced up to 300 cm. Paket içi adeti: 50 ADET / Products per box. Belirtilen hammadde kalınlıkları 0,60 mm dir. Thickness is 0,60 mm.



TEKNİK ÖLÇÜ TABLOSU

	8 mm	10 mm	12 mm	14 mm
W	8,5	8,5	8,5	8,5
H	10	12	14	16

PROFIX D

YUVARLAK KÖŞE
KORUMA PROFİLİ

TECHNOLINE

P Dizayn



Ebat size	Inox satinox	Dekorlu decor	Altın s gold	Bakır s bronze	Antrasit s. anthracite					
8 mm	PD0825001	22,5 \$	PD0825011	31,0 \$	PD0824421	30,5 \$	PD0824431	38,0 \$	PD0824441	38,0 \$
10 mm	PD1025001	23,0 \$	PD1025011	31,5 \$	PD1024421	31,0 \$	PD1024431	38,5 \$	PD1024441	38,5 \$
12 mm	PD1225001	23,5 \$	PD1225011	32,0 \$	PD1224421	31,5 \$	PD1224431	39,0 \$	PD1224441	39,0 \$
14 mm	PD1425001	24,0 \$	PD1425011	32,5 \$	PD1424421	32,0 \$	PD1424431	39,5 \$	PD1424441	39,5 \$

Ebat size	Inox Ayna mirror	Inox Parlak shine	Altın Ayna gold	Bakır Ayna bronze	Antrasit Ayna anthracite					
8 mm	PD0824400	26,5 \$	PD0825003	22,5 \$	PD0824420	30,5 \$	PD0824430	38,0 \$	PD0824440	38,0 \$
10 mm	PD1024400	27,0 \$	PD1025003	23,0 \$	PD1024420	31,0 \$	PD1024430	38,5 \$	PD1024440	38,5 \$
12 mm	PD1224400	27,5 \$	PD1225003	23,5 \$	PD1224420	31,5 \$	PD1224430	39,0 \$	PD1224440	39,0 \$
14 mm	PD1424400	28,0 \$	PD1425003	24,0 \$	PD1424420	32,0 \$	PD1424430	39,5 \$	PD1424440	39,5 \$

Profix D seramik , duvar kağıdı arasında kademesiz geçiş sağlayan dekoratif görünümlü paslanmaz çelikten üretilen duvar kağıdı, kot farklılık profilidir.

Seramik ve duvar kağıdı geçişi için kullanılan 304 kalite paslanmaz çelikten üretilen duvar kağıdı kot farklılık profilidir. 10 farklı renk alternatifi ile üretilmektedir. Renkli ürünler PVD teknolojisi ile paslanmaz yüzeye yüksek dayanıma sahip titanyum iyon kaplama yöntemi ile üretilmektedir.

Profix D is transition and wall covering profile produced from 4301 grade stainless steel with offered 10 different surface colour options . All colour options produced by PVD Technologies with high resistance titanium covered.

Inox (Satinox), Dekorlu (Decor), Inox Parlak (Shine) yüzeyler 250 cm boyda üretilmektedir. / Surfaces 250 cm lenght. Ayna (Mirror), Altın (Satine Gold), Altın ayna (Gold), Bakır (Satine bronze), Bakır Ayna (Bronze mirror), Antrasit (Satine Anthracite), Antrasit ayna (Anthracite mirror) yüzeyler 244 cm boyda üretilmektedir. / surfaces 244 cm lenght. Maximum boy 300 cm üretilmektedir. / Profile can be produced up to 300 cm. Paket içi adedi: 10 ADET / Products per box. Belirtilen hammadde kalınlıkları 0,80 mm dir, 0,60 mm için fiyat talep edilmelidir. Thickness is 0,80 mm. Should be request price for 0,60 mm alternatives.



TEKNİK ÖLÇÜ TABLOSU

	8 mm	10 mm	12 mm	14 mm
H	9,33	11,2	13,01	14,93



Ebat size	Inox satinox	Dekorlu decor	Altın s gold	Bakır s bronze	Antrasit s. anthracite
8 mm	TD0825001 18,6 \$	TD0825011 24,8 \$	TD0824421 22,1 \$	TD0824431 25,6 \$	TD0824441 25,6 \$
10 mm	TD1025001 19,0 \$	TD1025011 25,2 \$	TD1024421 22,5 \$	TD1024431 26,0 \$	TD1024441 26,0 \$
12 mm	TD1225001 19,4 \$	TD1225011 25,6 \$	TD1224421 22,9 \$	TD1224431 26,4 \$	TD1224441 26,4 \$
14 mm	TD1425001 19,8 \$	TD1425011 26,0 \$	TD1424421 23,3 \$	TD1424431 26,8 \$	TD1424441 26,8 \$

Ebat size	Inox Ayna mirror	Inox Parlak shine	Altın Ayna gold	Bakır Ayna bronze	Antrasit Ayna anthracite
8 mm	TD0824400 20,1 \$	TD0825003 18,6 \$	TD0824420 22,1 \$	TD0824430 25,6 \$	TD0824440 25,6 \$
10 mm	TD1024400 20,5 \$	TD1025003 19,0 \$	TD1024420 22,5 \$	TD1024430 26,0 \$	TD1024440 26,0 \$
12 mm	TD1224400 20,9 \$	TD1225003 19,4 \$	TD1224420 22,9 \$	TD1224430 26,4 \$	TD1224440 26,4 \$
14 mm	TD1424400 21,3 \$	TD1425003 19,8 \$	TD1424420 23,3 \$	TD1424430 26,8 \$	TD1424440 26,8 \$

Profix DE, seramik , duvar kağıdı arasında kademesiz geçiş sağlayan dekoratif görünümlü paslanmaz çelikten üretilen duvar kağıdı, kot farklılık profilidir.

Seramik ve duvar kağıdı geçişi için kullanılan 304 kalite paslanmaz çelikten üretilen duvar kağıdı kot farklılık profilidir. 10 farklı renk alternatifi ile üretilmektedir. Renkli ürünler PVD teknolojisi ile paslanmaz yüzeye yüksek dayanıma sahip titanyum iyon kaplama yöntemi ile üretilmektedir.

Profix DE is transition and wall covering profile produced from 4301 grade stainless steel with offered 10 different surface colour options . All colour options produced by PVD Technologies with high resistance titanium covered.

Inox (Satinox), Dekorlu (Decor), Inox Parlak (Shine) yüzeyler 250 cm boyda üretilmektedir. / Surfaces 250 cm lenght. Ayna (Mirror), Altın (Satine Gold), Altın ayna (Gold), Bakır (Satine bronze), Bakır Ayna (Bronze mirror), Antrasit (Satine Anthracite), Antrasit ayna (Anthracite mirror) yüzeyler 244 cm boyda üretilmektedir. / surfaces 244 cm lenght. Maximum boy 300 cm üretilmektedir. / Profile can be produced up to 300 cm. Paket içi adeti: 50 ADET / Products per box. Belirtilen hammadde kalınlıkları 0,60 mm dir. Thickness is 0,60 mm.



TEKNİK ÖLÇÜ TABLOSU

	8 mm	10 mm	12 mm	14 mm
H	9,33	11,2	13,01	14,93



Ebat size	Inox satinox	Dekorlu decor	Altın s gold	Bakır s bronze	Antrasit s. anthracite
8 mm	PL0825001 21,5 \$	PL0825011 31,0 \$	PL0824421 25,3 \$	PL0824431 28,8 \$	PL0824441 28,8 \$
10 mm	PL1025001 21,7 \$	PL1025011 31,5 \$	PL1024421 25,5 \$	PL1024431 29,0 \$	PL1024441 29,0 \$
12 mm	PL1225001 21,9 \$	PL1225011 32,0 \$	PL1224421 25,7 \$	PL1224431 29,2 \$	PL1224441 29,2 \$
14 mm	PL1425001 22,2 \$	PL1425011 32,5 \$	PL1424421 25,9 \$	PL1424431 29,4 \$	PL1424441 29,4 \$

Ebat size	Inox Ayna mirror	Inox Parlak shine	Altın Ayna gold	Bakır Ayna bronze	Antrasit Ayna anthracite
8 mm	PL0824400 23,0 \$	PL0825003 21,5 \$	PL0824420 25,3 \$	PL0824430 28,8 \$	PL0824440 28,8 \$
10 mm	PL1024400 23,5 \$	PL1025003 21,7 \$	PL1024420 25,5 \$	PL1024430 29,0 \$	PL1024440 29,0 \$
12 mm	PL1224400 24,0 \$	PL1225003 21,9 \$	PL1224420 25,7 \$	PL1224430 29,2 \$	PL1224440 29,2 \$
14 mm	PL1424400 24,5 \$	PL1425003 22,2 \$	PL1424420 25,9 \$	PL1424430 29,4 \$	PL1424440 29,4 \$

Profix L seramik yüzeylerin dış köşelerini korumak amacıyla kullanılan dekoratif görünümlü paslanmaz çelikten üretilen L dış kenar bitiş profilidir. Seramik yüzeylerin dış köşelerini korumak için 304 kalite paslanmaz çelikten üretilen L dış kenar bitiş profilidir. 10 farklı renk alternatifleri ile üretilmektedir. Renkli ürünler PVD teknolojisi ile paslanmaz yüzeye yüksek dayanıma sahip titanyum iyon kaplama yöntemi ile üretilmektedir. Profix L is shape outer edge profile produced from 4301 grade stainless steel with offered 10 different surface colour options. All colour options produced by PVD technologies with high resistance titanium covered.

Inox (Satinox), Dekorlu (Decor), Inox Parlak (Shine) yüzeyler 250 cm boyda üretilmektedir. / Surfaces 250 cm length. Ayna (Mirror), Altın (Satine Gold), Altın ayna (Gold), Bakır (Satine bronze), Bakır Ayna (Bronze mirror), Antrasit (Satine Anthracite), Antrasit ayna (Anthracite mirror) yüzeyler 244 cm boyda üretilmektedir. / surfaces 244 cm length. Maximum boy 300 cm üretilmektedir. / Profile can be produced up to 300 cm. Paket içi adeti: 25 ADET / Products per box. Belirtilen hammadde kalınlıkları 0,80 mm dir, 0,60 mm için fiyat talep edilmelidir. Thickness is 0,80 mm. Should be request price for 0,60 mm alternatives.

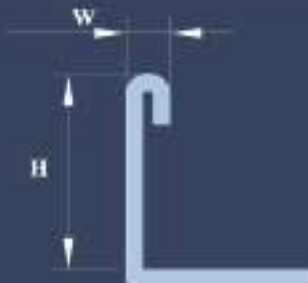

TEKNİK ÖLÇÜ TABLOSU

	8 mm	10 mm	12 mm	14 mm
W	2,13	2,58	3,03	3,48
H	9,5	11,5	13,5	15,5



Ebat size	Inox satinox	Dekorlu decor	Altın s gold	Bakır s bronze	Antrasit s. anthracite
8 mm	TL0825001 15,6 \$	TL0825011 24,8 \$	TL0824421 19,3 \$	TL0824431 22,3 \$	TL0824441 22,3 \$
10 mm	TL1025001 16,0 \$	TL1025011 25,2 \$	TL1024421 19,5 \$	TL1024431 22,5 \$	TL1024441 22,5 \$
12 mm	TL1225001 16,4 \$	TL1225011 25,6 \$	TL1224421 19,7 \$	TL1224431 22,7 \$	TL1224441 22,7 \$
14 mm	TL1425001 16,8 \$	TL1425011 26,0 \$	TL1424421 19,9 \$	TL1424431 22,9 \$	TL1424441 22,9 \$

Ebat size	Inox Ayna mirror	Inox Parlak shine	Altın Ayna gold	Bakır Ayna bronze	Antrasit Ayna anthracite
8 mm	TL0824400 18,4 \$	TL0825003 15,6 \$	TL0824420 19,3 \$	TL0824430 22,3 \$	TL0824440 22,3 \$
10 mm	TL1024400 18,8 \$	TL1025003 16,0 \$	TL1024420 19,5 \$	TL1024430 22,5 \$	TL1024440 22,5 \$
12 mm	TL1224400 19,2 \$	TL1225003 16,4 \$	TL1224420 19,7 \$	TL1224430 22,7 \$	TL1224440 22,7 \$
14 mm	TL1424400 19,6 \$	TL1425003 16,8 \$	TL1424420 19,9 \$	TL1424430 22,9 \$	TL1424440 22,9 \$

Profix LE seramik yüzeylerin dış köşelerini korumak amacıyla kullanılan dekoratif görünümlü paslanmaz çelikten üretilen L dış kenar bitiş profilidir. Seramik yüzeylerin dış köşelerini korumak için 304 kalite paslanmaz çelikten üretilen L dış kenar bitiş profilidir. 10 farklı renk alternatifi ile üretilmektedir. Renkli ürünler PVD teknolojisi ile paslanmaz yüzeye yüksek dayanıma sahip titanyum iyon kaplama yöntemi ile üretilmektedir. Profix LE is shape outer edge profile produced from 4301 grade stainless steel with offered 10 different surface colour options. All colour options produced by PVD technologies with high resistance titanium covered.

Inox (Satinox), Dekorlu (Decor), Inox Parlak (Shine) yüzeyler 250 cm boyda üretilmektedir. / Surfaces 250 cm length. Ayna (Mirror), Altın (Satine Gold), Altın ayna (Gold), Bakır (Satine bronze), Bakır Ayna (Bronze mirror), Antrasit (Satine Anthracite), Antrasit ayna (Anthracite mirror) yüzeyler 244 cm boyda üretilmektedir. / surfaces 244 cm length. Maximum boy 300 cm üretilmektedir. / Profile can be produced up to 300 cm. Paket içi adeti: 50 ADET / Products per box. Belirtilen hammadde kalınlıkları 0,60 mm dir. Thickness is 0,60 mm.

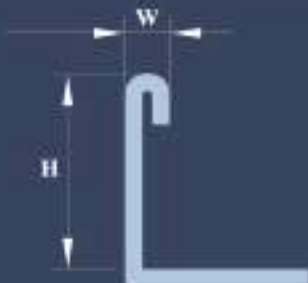

TEKNİK ÖLÇÜ TABLOSU

	8 mm	10 mm	12 mm	14 mm
W	2,13	2,58	3,03	3,48
H	9,5	11,5	13,5	15,5

PROFIX U

DAHİLİ İÇ
KÖŞE PROFİLİ

TECHNOLINE

R Dizayn

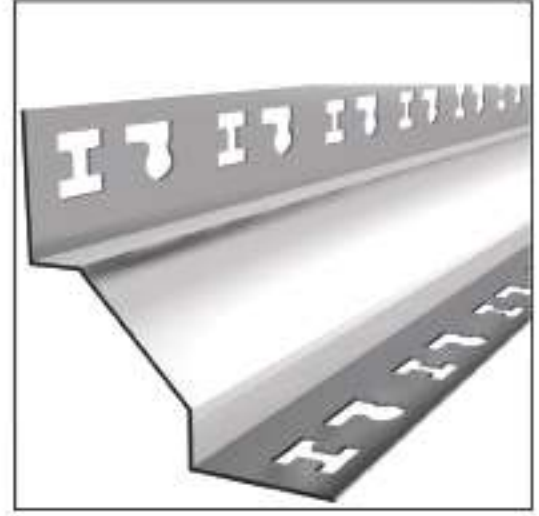

Ebat size	Inox satinox	Dekorlu decor	Altın s gold	Bakır s bronze	Antrasit s. anthracite
9 mm	PU0925001 36,0 \$	PU0925011 55,0 \$	PU0924421 55,0 \$	PU0924431 70,0 \$	PU0924441 70,0 \$
11 mm	PU1125001 36,5 \$	PU1125011 55,5 \$	PU1124421 55,5 \$	PU1224431 70,5 \$	PU1224441 70,5 \$
16 mm	PU1625001 40,0 \$	PU1625011 70,0 \$	PU1624421 70,0 \$	PU1624431 85,0 \$	PU1624441 85,0 \$

Ebat size	Inox Ayna mirror	Inox Parlak shine	Altın Ayna gold	Bakır Ayna bronze	Antrasit Ayna anthracite
9 mm	PU0924400 43,0 \$	PU0925003 36,0 \$	PU0924420 55,0 \$	PU0924430 70,0 \$	PU0924440 70,0 \$
11 mm	PU1124400 43,5 \$	PU1125003 36,5 \$	PU1124420 55,5 \$	PU1124430 70,5 \$	PU1124440 70,5 \$
16 mm	PU1624400 50,0 \$	PU1625003 40,0 \$	PU1624420 70,0 \$	PU1624430 85,0 \$	PU1624440 85,0 \$

Profix U seramik kaplamaların iç köşelerinde dekoratif ve temiz bir birleşim detayı oluşturan paslanmaz çelikten üretilen dahili iç köşe profilidir. Seramik yüzeylerin iç köşeleri için 304 kalite paslanmaz çelikten üretilen iç köşe profilidir. 10 farklı renk alternatifi ile üretilmektedir. Renkli ürünler PVD teknolojisi ile paslanmaz yüzeye yüksek dayanıma sahip titanyum iyon kaplama yöntemi ile üretilmektedir. Profix U is inner corner edge profile produced from 4301 grade stainless steel with offered 10 different surface colour options. All colour options produced by PVD technologies with high resistance titanium covered.

Inox (Satinox), Dekorlu (Decor), Inox Parlak (Shine) yüzeyler 250 cm boyda üretilmektedir. / Surfaces 250 cm length. Ayna (Mirror), Altın (Satine Gold), Altın ayna (Gold), Bakır (Satine bronze), Bakır Ayna (Bronze mirror), Antrasit (Satine Anthracite), Antrasit ayna (Anthracite mirror) yüzeyler 244 cm boyda üretilmektedir. / surfaces 244 cm length. Maximum boy 300 cm üretilmektedir. / Profile can be produced up to 300 cm. Paket içi adeti: 6 ADET / Products per box. Belirtilen hammadde kalınlıkları 0,80 mm dir, 0,60 mm için fiyat talep edilmelidir. Thickness is 0,80 mm. Should be request price for 0,60 mm alternatives.



TEKNİK ÖLÇÜ TABLOSU

	9 mm	11 mm	16 mm
W	9	11	16
H	23	21	16



Ebat size	Inox satinox	Dekorlu decor	Altın s. gold	Bakır s. bronze	Antrasit s. anthracite
9 mm	PUT0925001 23,0 \$	PUT0925011 36,0 \$	PUT0924421 36,0 \$	PUT0924431 46,0 \$	PUT0924441 46,0 \$
11 mm	PUT1125001 23,5 \$	PUT1125011 36,5 \$	PUT1124421 36,5 \$	PUT1124431 46,5 \$	PUT1124441 46,5 \$
16 mm	PUT1625001 28,0 \$	PUT1625011 42,0 \$	PUT1624421 42,0 \$	PUT1624431 52,0 \$	PUT1624441 52,0 \$

Ebat size	Inox Ayna mirror	Inox Parlak shine	Altın Ayna gold	Bakır Ayna bronze	Antrasit Ayna anthracite
9 mm	PUT0924400 28,5 \$	PUT0925003 23,0 \$	PUT0924420 36,0 \$	PUT0924430 46,0 \$	PUT0924440 46,0 \$
11 mm	PUT1124400 29,0 \$	PUT1125003 23,5 \$	PUT1124420 36,5 \$	PUT1124430 46,5 \$	PUT1124440 46,5 \$
16 mm	PUT1624400 35,0 \$	PUT1625003 28,0 \$	PUT1624420 42,0 \$	PUT1624430 52,0 \$	PUT1624440 52,0 \$

Profix UT seramik kaplamaların iç köşelerinde dekoratif ve temiz bir birleşim detayı oluşturan paslanmaz çelikten üretilen dahili iç köşe profilidir. Seramik yüzeylerin iç köşeleri için 304 kalite paslanmaz çelikten üretilen iç köşe profilidir. 10 farklı renk alternatifini üretilmektedir. Renkli ürünler PVD teknolojisi ile paslanmaz yüzeye yüksek dayanıma sahip titanyum iyon kaplama yöntemi ile üretilmektedir.

Profix UT is inner corner edge profile produced from 4301 grade stainless steel with offered 10 different surface colour options. All colour options produced by PVD technologies with high resistance titanium covered.

Inox (Satinox), Dekorlu (Decor), Inox Parlak (Shine) yüzeyler 250 cm boyda üretilmektedir. / Surfaces 250 cm length. Ayna (Mirror), Altın (Satine Gold), Altın ayna (Gold), Bakır (Satine bronze), Bakır Ayna (Bronze mirror), Antrasit (Satine Anthracite), Antrasit ayna (Anthracite mirror) yüzeyler 244 cm boyda üretilmektedir. / surfaces 244 cm length. Maximum boy 300 cm üretilmektedir. / Profile can be produced up to 300 cm. Paket içi adeti: 6 ADET / Products per box. Belirtilen hammadde kalınlıkları 0,80 mm dir, 0,60 mm için fiyat talep edilmelidir. Thickness is 0,80 mm. Should be request price for 0,60 mm alternatives.



TEKNİK ÖLÇÜ TABLOSU

	9 mm	11 mm	16 mm
W	9	11	16
H	23	21	16

PROFIX UE

DAHİLİ İÇ
KÖŞK PROFİLİ

TECHNOLINE

P Dizayn



Ebat size	Inox satinox	Dekorlu decor	Altın s gold	Bakır s bronze	Antrasit s. anthracite					
8 mm	TU0825001	18,6 \$	TU0825011	24,8 \$	TU0824421	22,1 \$	TU0824431	25,6 \$	TU0824441	25,6 \$
10 mm	TU1025001	19,0 \$	TU1025011	25,2 \$	TU1024421	22,5 \$	TU1024431	26,0 \$	TU1024441	26,0 \$
12 mm	TU1225001	19,4 \$	TU1225011	25,6 \$	TU1224421	22,9 \$	TU1224431	26,4 \$	TU1224441	26,4 \$
14 mm	TU1425001	19,8 \$	TU1425011	26,0 \$	TU1424421	23,3 \$	TU1424431	26,8 \$	TU1424441	26,8 \$

Ebat size	Inox Ayna mirror	Inox Parlak shine	Altın Ayna gold	Bakır Ayna bronze	Antrasit Ayna anthracite					
8 mm	TU0824400	20,1 \$	TU0825003	18,6 \$	TU0824420	22,1 \$	TU0824430	25,6 \$	TU0824440	25,6 \$
10 mm	TU1024400	20,5 \$	TU1025003	19,0 \$	TU1024420	22,5 \$	TU1024430	26,0 \$	TU1024440	26,0 \$
12 mm	TU1224400	20,9 \$	TU1225003	19,4 \$	TU1224420	22,9 \$	TU1224430	26,4 \$	TU1224440	26,4 \$
14 mm	TU1424400	21,3 \$	TU1425003	19,8 \$	TU1424420	23,3 \$	TU1424430	26,8 \$	TU1424440	26,8 \$

Profix UE seramik kaplamaların iç köşelerinde dekoratif ve temiz bir birleşim detayı oluşturan paslanmaz çelikten üretilen dahili iç köşe profilidir. Seramik yüzeylerin iç köşeleri için 304 kalite paslanmaz çelikten üretilen iç köşe profilidir. 10 farklı renk alternatifi ile üretilmektedir. Renkli ürünler PVD teknolojisi ile paslanmaz yüzeye yüksek dayanıma sahip titanyum iyon kaplama yöntemi ile üretilmektedir. Profix UE is inner corner edge profile produced from 4301 grade stainless steel with offered 10 different surface colour options. All colour options produced by PVD technologies with high resistance titanium covered.

Inox (Satinox), Dekorlu (Decor), Inox Parlak (Shine) yüzeyler 250 cm boyda üretilmektedir. / Surfaces 250 cm length. Ayna (Mirror), Altın (Satine Gold), Altın ayna (Gold), Bakır (Satine bronze), Bakır Ayna (Bronze mirror), Antrasit (Satine Anthracite), Antrasit ayna (Anthracite mirror) yüzeyler 244 cm boyda üretilmektedir. / surfaces 244 cm length. Maximum boy 300 cm üretilmektedir. / Profile can be produced up to 300 cm. Paket içi adeti: 50 ADET / Products per box. Belirtilen hammadde kalınlıkları 0,60 mm dir. Thickness is 0,60 mm.



TEKNİK ÖLÇÜ TABLOSU

	8 mm	10 mm	12 mm	14 mm
W	15	15	15	10
H	8	10	12	14



Ebat size	Inox satinox	Dekorlu decor	Altın s gold	Bakır s bronze	Antrasit s. anthracite
20/10 mm	PC201025001 42 \$	PC201025011 73 \$	PC201024421 73 \$	PC201024431 93 \$	PC201024441 93 \$
20/12 mm	PC201225001 43 \$	PC201225011 74 \$	PC201224421 74 \$	PC201224431 94 \$	PC201224441 94 \$

Ebat size	Inox Ayna mirror	Inox Parlak shine	Altın Ayna gold	Bakır Ayna bronze	Antrasit Ayna anthracite
20/10 mm	PC201024400 60 \$	PC201025003 42 \$	PC201024420 73 \$	PC201024430 93 \$	PC201024440 93 \$
20/12 mm	PC201224400 61 \$	PC201225003 43 \$	PC201224420 74 \$	PC201224430 94 \$	PC201224440 94 \$

Profix C Seramik , mermer vb . kaplamaların dış köşelerinde dekoratif görünümlü paslanmaz çelikten üretilen dahili dış köşe koruma profilidir. Mekanik darbelerin fazla olacağı düşünülen alanlarda (Endüstriyel mutfak,hastaneler ,kamu alanları ,fabrikalar vb...) dekoratif görünüm sağlayan dış köşe koruma profilidir.

Profix C is internal outer edge protection profile produced from 4301 grade stainless steel with offered 10 different surface color options . All colour options produced by PVD Technologies with high resistance titanium covered.

Inox (Satinox), Dekorlu (Decor), Inox Parlak (Shine) yüzeyler 250 cm boyda üretilmektedir. / Surfaces 250 cm lenght. Ayna (Mirror), Altın (Satine Gold), Altın ayna (Gold), Bakır (Satine bronze), Bakır Ayna (Bronze mirror), Antrasit (Satine Anthracite), Antrasit ayna (Anthracite mirror) yüzeyler 244 cm boyda üretilmektedir. / surfaces 244 cm lenght. Maximum boy 300 cm üretilmektedir. / Profile can be produced up to 300 cm. Paket içi adeti: 6 ADET / Products per box. Belirtilen hammadde kalınlıkları 0,80 mm dir, 0,60 mm için fiyat talep edilmelidir. Thickness is 0,80 mm. Should be request price for 0,60 mm alternatives.



TEKNİK ÖLÇÜ TABLOSU

	10 mm	12 mm
W	20	20
H	10	12

PROFIX 45

AÇILI KÖŞE
KORUMA PROFİLİ

TECHNOLINE

P Dizayn



Ebat size	Inox satinox	Dekorlu decor	Altın s gold	Bakır s bronze	Antrasit s. anthracite
8 mm	PB450825001 29,0 \$	PB450825011 38,5 \$	PB450824421 48,0 \$	PB450824431 57,0 \$	PB450824441 57,5 \$
10 mm	PB451025001 29,5 \$	PB451025011 39,0 \$	PB451024421 48,5 \$	PB451024431 58,0 \$	PB451024441 58,0 \$
12 mm	PB451225001 30,0 \$	PB451225011 39,5 \$	PB451224421 49,0 \$	PB451224431 58,5 \$	PB451224441 58,5 \$
14 mm	PB451425001 30,5 \$	PB451425011 40,0 \$	PB451424421 49,5 \$	PB451424431 59,0 \$	PB451424441 59,0 \$

Ebat size	Inox Ayna mirror	Inox Parlak shine	Altın Ayna gold	Bakır Ayna bronze	Antrasit Ayna anthracite
8 mm	PB450824400 38,5 \$	PB450825003 29,0 \$	PB450824420 48,0 \$	PB450824430 57,5 \$	PB450824440 57,5 \$
10 mm	PB451024400 39,0 \$	PB451025003 29,5 \$	PB451024420 48,5 \$	PB451024430 58,0 \$	PB451024440 58,0 \$
12 mm	PB451224400 39,5 \$	PB451225003 30,0 \$	PB451224420 49,0 \$	PB451224430 58,5 \$	PB451224440 58,5 \$
14 mm	PB451424400 40,0 \$	PB451425003 30,5 \$	PB451424420 49,5 \$	PB451424430 59,0 \$	PB451424440 59,0 \$

Profix 45 seramik kaplamalarda 45 derece dış köşelerinde kullanılan paslanmaz çelikten üretilen açılı köşe koruma profilidir.

Seramik kaplamalarda 45 derece dış köşelerinde kullanılan paslanmaz çelikten üretilen açılı köşe koruma profilidir. 10 farklı renk alternatifleri ile üretilmektedir. Renkli ürünler PVD teknolojisi ile paslanmaz yüzeye yüksek dayanıma sahip titanyum iyon kaplama yöntemi ile üretilmektedir.

Profix 45 is corner edge protection profile produced from 4301 grade stainless steel with offered 10 different surface colour options. All colour options produced by PVD technologies with high resistance titanium covered.

Inox (Satinox), Dekorlu (Decor), Inox Parlak (Shine) yüzeyler 250 cm boyda üretilmektedir. / Surfaces 250 cm length. Ayna (Mirror), Altın (Satine Gold), Altın ayna (Gold), Bakır (Satine bronze), Bakır Ayna (Bronze mirror), Antrasit (Satine Anthracite), Antrasit ayna (Anthracite mirror) yüzeyler 244 cm boyda üretilmektedir. / surfaces 244 cm length. Maximum boy 300 cm üretilmektedir. / Profile can be produced up to 300 cm. Paket içi adeti: 10 ADET / Products per box. Belirtilen hammadde kalınlıkları 0,80 mm dir, 0,60 mm için fiyat talep edilmelidir. Thickness is 0,80 mm. Should be request price for 0,60 mm alternatives.



TEKNİK ÖLÇÜ TABLOSU

	8 mm	10 mm	12 mm	14 mm
H	10	12	14	16

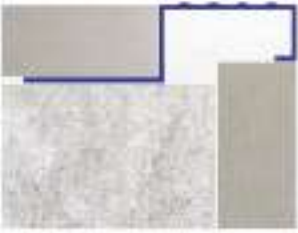

Ebat size	Inox satinox		Dekorlu decor	
11 mm	PS1125001	46 \$	PS1125011	55 \$
13 mm	PS1325001	46 \$	PS1325011	55 \$
25 mm	PS2525001	46 \$	PS2525011	55 \$

Ebat size	Inox Parlak Shine	
11 mm	PS1125003	46 \$
13 mm	PS1325003	46 \$
25 mm	PS2525003	46 \$

Profix S merdiven basamaklarının kenarları için kullanılan emniyetli ve kaymayı engelleyici özel yüzeyi ile paslanmaz çelikten üretilen dahili merdiven köşe koruma profilidir. Kaymayı önleyen özel yüzeyi ile 304 kalite paslanmaz çelikten üretilen merdiven profilidir. 10 farklı renk alternatifini ile üretilmektedir. Renkli ürünler PVD teknolojisi ile paslanmaz yüzeye yüksek dayanıma sahip titanyum iyon kaplama yöntemi ile üretilmektedir. Profix S is internal stairs edge protection profile produced from 4301 grade stainless steel with offered 10 different surface colour options. All colour options produced by PVD technologies with high resistance titanium ion covered.

Inox (Satinox), Dekorlu (Decor), Inox Parlak (Shine) yüzeyler 250 cm boyda üretilmektedir. / Surfaces 250 cm length. Ayna (Mirror), Altın (Satine Gold), Altın ayna (Gold), Bakır (Satine bronze), Bakır Ayna (Bronze mirror), Antrasit (Satine Antracite), Antrasit ayna (Antracite mirror) yüzeyler 244 cm boyda üretilmektedir. / surfaces 244 cm length. Maximum boy 300 cm üretilmektedir. / Profile can be produced up to 300 cm. Paket içi adeti: 6 ADET / Products per box. Belirtilen hammadde kalınlıkları 0,80 mm dir, 0,60 mm için fiyat talep edilmelidir. Thickness is 0,80 mm. Should be request price for 0,60 mm alternatives.

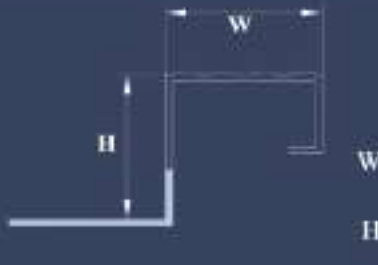

TEKNİK ÖLÇÜ TABLOSU

	10 mm	12 mm	14 mm
W	30	30	30
H	11,5	13,5	15,5

PROFIX R

HARİCİ DİŞ KÖŞE
KORUMA PROFİLİ

TECHNOLINE

P Dizayn



Ebat size	Inox satinox	Dekorlu decor	Altın s gold	Bakır s bronze	Antrasit s. anthracite
15 mm	PR1525001 16,5 \$	PR1525011 30 \$	PR1524421 30 \$	PR1524431 40 \$	PR1524441 40 \$
32 mm	PR3225001 24,5 \$	PR3225011 42 \$	PR3224421 42 \$	PR3224431 47 \$	PR3224441 47 \$

Ebat size	Inox Ayna mirror	Inox Parlak shine	Altın Ayna gold	Bakır Ayna bronze	Antrasit Ayna anthracite
15 mm	PR1524400 22 \$	PR1525003 16,5 \$	PR1524420 30 \$	PR1524430 40 \$	PR1524440 40 \$
32 mm	PR3224400 30 \$	PR3225003 24,5 \$	PR3224420 42 \$	PR3224430 47 \$	PR3224440 47 \$

Profix R seramik ve farklı kaplama malzemelerinin dış köşelerine uygulama sonrası yapıştırarak uygulanabilen hem dekoratif hem de mekanik dayanım sağlayan paslanmaz çelikten üretilen harici dış köşe koruma profilidir.

Seramik ve farklı kaplama malzemelerinin dış köşeleri için 304 kalite paslanmaz çelikten üretilen dekoratif görünümlü harici dış köşe koruma profilidir. 10 farklı renk alternatifi ile üretilmektedir. Renkli ürünler PVD teknolojisi ile paslanmaz yüzeye yüksek dayanıma sahip titanyum iyon kaplama yöntemi ile üretilmektedir.

Profix R is internal outer corner edge protection profile produced from 4301 grade stainless steel with offered 10 different surface color options. All color options produced by PVD Technologies with high resistance titanium ion covered .

Inox (Satinox), Dekorlu (Decor), Inox Parlak (Shine) yüzeyler 250 cm boyda üretilmektedir. / Surfaces 250 cm length. Ayna (Mirror), Altın (Satine Gold), Altın ayna (Gold), Bakır (Satine bronze), Bakır Ayna (Bronze mirror), Antrasit (Satine Anthracite), Antrasit ayna (Anthracite mirror) yüzeyler 244 cm boyda üretilmektedir. / surfaces 244 cm length. Maximum boy 300 cm üretilmektedir. / Profile can be produced up to 300 cm. Paket içi adeti: 10 ADET / Products per box. Belirtilen hammadde kalınlıkları 0,80 mm dir, 0,60 mm için fiyat talep edilmelidir. Thickness is 0,80 mm. Should be request price for 0,60 mm alternatives.



TEKNİK ÖLÇÜ TABLOSU

	15 mm	32 mm
H	15	32



Ebat size	Inox satinox	Dekorlu decor	Altın s gold	Bakır s bronze	Antrasit s. anthracite
15 mm	PV1525001	16,5 \$	PV1524421	30 \$	PV1524431
32 mm	PV3225001	24,5 \$	PV3224421	42 \$	PV3224431

Ebat size	Inox Ayna mirror	Inox Parlak shine	Altın Ayna gold	Bakır Ayna bronze	Antrasit Ayna anthracite
15 mm	PV1524400	22 \$	PV1524420	30 \$	PV1524430
32 mm	PV3224400	30 \$	PV3224420	42 \$	PV3224430

Profix V seramik ve farklı kaplama malzemelerinin iç köşelerinde dekoratif ve temiz birleşim detayı oluşturmak amacıyla kullanılan paslanmaz çelikten üretilen harici iç köşe koruma profilidir.

Seramik ve farklı kaplama malzemelerinin iç köşeleri için 304 kalite paslanmaz çelikten üretilen dekoratif görünümlü harici iç köşe koruma profilidir. 10 farklı renk alternatifini ile üretilmektedir. Renkli ürünler PVD teknolojisi ile paslanmaz yüzeye yüksek dayanıma sahip titanyum iyon kaplama yöntemi ile üretilmektedir.

Profix V is internal outer corner edge protection profile produced from 4301 grade stainless steel with offered 10 different surface colour options. All colour options produced by PVD technologies with high resistance titanium ion covered.

Inox (Satinox), Dekorlu (Decor), Inox Parlak (Shine) yüzeyler 250 cm boyda üretilmektedir. / Surfaces 250 cm length. Ayna (Mirror), Altın (Satine Gold), Altın ayna (Gold), Bakır (Satine bronze), Bakır Ayna (Bronze mirror), Antrasit (Satine Anthracite), Antrasit ayna (Anthracite mirror) yüzeyler 244 cm boyda üretilmektedir. / surfaces 244 cm length. Maximum boy 300 cm üretilmektedir. / Profile can be produced up to 300 cm. Paket içi adeti: 6 ADET / Products per box. Belirtilen hammadde kalınlıkları 0,80 mm dir, 0,60 mm için fiyat talep edilmelidir. Thickness is 0,80 mm. Should be request price for 0,60 mm alternatives.

TEKNİK ÖLÇÜ TABLOSU

		15 mm	32 mm
H	H	15	32

PROFIX
KOT K

TECHNOLINE

DAHİLİ KOT PROFİLİ

P Dizayn

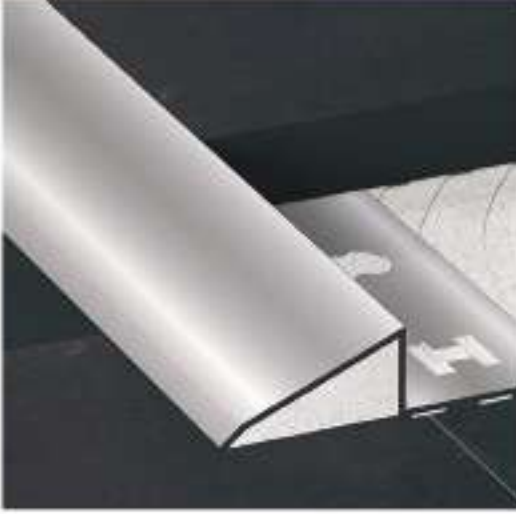

Ebat size	Inox satinox	Dekorlu decor	Altın s gold	Bakır s bronze	Antrasit s. anthracite					
8 mm	PK0825001	30 \$	PK0825011	35 \$	PK0824421	55 \$	PK0824431	75 \$	PK0824441	67,0 \$
10 mm	PK1025001	30 \$	PK1025011	35 \$	PK1024421	55 \$	PK1024431	75 \$	PK1024441	67,0 \$
12 mm	PK1225001	30 \$	PK1225011	35 \$	PK1224421	55 \$	PK1224431	75 \$	PK1224441	67,0 \$
14 mm	PK1425001	42 \$	PK1425011	49 \$	PK1424421	77 \$	PK1424431	105 \$	PK1424441	93,8 \$
20 mm	PK2025001	42 \$	PK2025011	49 \$	PK2024421	77 \$	PK2024431	105 \$	PK2024441	93,8 \$

Ebat size	Inox Ayna mirror	Inox Parlak shine	Altın Ayna gold	Bakır Ayna bronze	Antrasit Ayna anthracite					
8 mm	PK0824400	45 \$	PK0825003	30 \$	PK0824420	55 \$	PK0824430	75 \$	PK0824440	67,0 \$
10 mm	PK1024400	45 \$	PK1025003	30 \$	PK1024420	55 \$	PK1024430	75 \$	PK1024440	67,0 \$
12 mm	PK1224400	45 \$	PK1225003	30 \$	PK1224420	55 \$	PK1224430	75 \$	PK1224440	67,0 \$
14 mm	PK1424400	63 \$	PK1425003	42 \$	PK1424420	77 \$	PK1424430	105 \$	PK1424440	93,8 \$
20 mm	PK2024400	63 \$	PK2025003	42 \$	PK2024420	77 \$	PK2024430	105 \$	PK2024440	93,8 \$

Profix Kot K seramik, mermer ve tüm kaplamalarda kademesiz geçişi sağlayan dekoratif görünümlü paslanmaz çelikten üretilen kot farklılık profildir. Seramik ,mermer ve tüm kaplamalarda kademesiz geçişi sağlayan 304 kalite paslanmaz çelikten üretilen kot farklılık profildir. 10 farklı renk alternatifleri ile üretilmektedir. Renkli ürünler PVD teknolojisi ile paslanmaz yüzeye yüksek dayanıma sahip titanyum iyon kaplama yöntemi ile üretilmektedir. Profix KOT K is stepless transition profile produced from 4301 grade stainless steel with offered 10 different surface color options. All colour options produced by PVD Technologies with high resistance titanium covered .

Inox (Satinox), Dekorlu (Decor), Inox Parlak (Shine) yüzeyler 250 cm boyda üretilmektedir. / Surfaces 250 cm length. Ayna (Mirror), Altın (Satine Gold), Altın ayna (Gold), Bakır (Satine bronze), Bakır Ayna (Bronze mirror),Antrasit (Satine Anthracite), Antrasit ayna (Anthracite mirror) yüzeyler 244 cm boyda üretilmektedir. / surfaces 244 cm length. Maximum boy 300 cm üretilmektedir. / Profile can be produced up to 300 cm. Paket içi adeti: 8 ADET / Products per box. Belirtilen hammadde kalınlıkları 0,80 mm dir, 0,60 mm için fiyat talep edilmelidir. Thickness is 0,80 mm. Should be request price for 0,60 mm alternatives.

TEKNİK ÖLÇÜ TABLOSU



	08 mm	10 mm	12 mm	14 mm	20 mm
W	30	30	30	30	30
H	9,5	11,5	13,5	15,5	21,5



Ebat size	Inox satinox	Dekorlu decor	Altın s gold	Bakır s bronz	Antrasit s. anthracite
8 mm	PZ0825001	30 \$ PZ0825011	35 \$ PZ0824421	55 \$ PZ0824431	75 \$ PZ0824441
10 mm	PZ1025001	30 \$ PZ1025011	35 \$ PZ1024421	55 \$ PZ1024431	75 \$ PZ1024441
12 mm	PZ1225001	30 \$ PZ1225011	35 \$ PZ1224421	55 \$ PZ1224431	75 \$ PZ1224441
14 mm	PZ1425001	42 \$ PZ1425011	49 \$ PZ1424421	77 \$ PZ1424431	105 \$ PZ1424441
20 mm	PZ2025001	42 \$ PZ2025011	49 \$ PZ2024421	77 \$ PZ2024431	105 \$ PZ2024441

Ebat size	Inox Ayna mirror	Inox Parlak shine	Altın Ayna gold	Bakır Ayna bronz	Antrasit Ayna anthracite
8 mm	PZ0824400	45 \$ PZ0825003	30 \$ PZ0824420	55 \$ PZ0824430	75 \$ PZ0824440
10 mm	PZ1024400	45 \$ PZ1025003	30 \$ PZ1024420	55 \$ PZ1024430	75 \$ PZ1024440
12 mm	PZ1224400	45 \$ PZ1225003	30 \$ PZ1224420	55 \$ PZ1224430	75 \$ PZ1224440
14 mm	PZ1424400	63 \$ PZ1425003	42 \$ PZ1424420	77 \$ PZ1424430	105 \$ PZ1424440
20 mm	PZ2024400	63 \$ PZ2025003	42 \$ PZ2024420	77 \$ PZ2024430	105 \$ PZ2024440

Profix Kot Z seramik, mermer ve tüm kaplamalarda kademesiz geçişi sağlayan dekoratif görünümlü paslanmaz çelikten üretilen kot farklılık profilidir. Seramik, mermer ve tüm kaplamalarda kademesiz geçişi sağlayan 304 kalite paslanmaz çelikten üretilen kot farklılık profilidir. 10 farklı renk alternatifi ile üretilmektedir. Renkli ürünler PVD teknolojisi ile paslanmaz yüzeye yüksek dayanıma sahip titanyum iyon kaplama yöntemi ile üretilmektedir.

Profix KOT Z is stepless transition profile produced from 4301 grade stainless steel with offered 10 different surface color options. All colour options produced by PVD Technologies with high resistance titanium covered.

Inox (Satinox), Dekorlu (Decor), Inox Parlak (Shine) yüzeyler 250 cm boyda üretilmektedir. / Surfaces 250 cm lenght. Ayna (Mirror), Altın (Satine Gold), Altın ayna (Gold), Bakır (Satine bronz), Bakır Ayna (Bronze mirror), Antrasit (Satine Anthracite), Antrasit ayna (Anthracite mirror) yüzeyler 244 cm boyda üretilmektedir. / surfaces 244 cm lenght. Maximum boy 300 cm üretilmektedir. / Profile can be produced up to 300 cm. Paket içi adeti: 6 ADET / Products per box. Belirtilen hammadde kalınlıkları 0,80 mm dir, 0,60 mm için fiyat talep edilmelidir. Thickness is 0,80 mm. Should be request price for 0,60 mm alternatives.

TEKNİK ÖLÇÜ TABLOSU

	08 mm	10 mm	12 mm	14 mm	20 mm
W	30	30	30	30	30
H	9,5	11,5	13,5	15,5	21,5



Ebat size	Inox satinox	Dekorlu decor	Altın s gold	Bakır s bronze	Antrasit s. anthracite
8 mm	PN0825001 30 \$	PN0825011 35 \$	PN0824421 55 \$	PN0824431 75 \$	PN0824441 67 \$
10 mm	PN1025001 30 \$	PN1025011 35 \$	PN1024421 55 \$	PN1024431 75 \$	PN1024441 67 \$
12 mm	PN1225001 30 \$	PN1225011 35 \$	PN1224421 55 \$	PN1224431 75 \$	PN1224441 67 \$
14 mm	PN1425001 42 \$	PN1425011 49 \$	PN1424421 77 \$	PN1424431 105 \$	PN1424441 94 \$
20 mm	PN2025001 42 \$	PN2025011 49 \$	PN2024421 77 \$	PN2024431 105 \$	PN2024441 94 \$

Ebat size	Inox Ayna mirror	Inox Parlak shine	Altın Ayna gold	Bakır Ayna bronze	Antrasit Ayna anthracite
8 mm	PN0824400 45 \$	PN0825003 30 \$	PN0824420 55 \$	PN0824430 75 \$	PN0824440 67 \$
10 mm	PN1024400 45 \$	PN1025003 30 \$	PN1024420 55 \$	PN1024430 75 \$	PN1024440 67 \$
12 mm	PN1224400 45 \$	PN1225003 30 \$	PN1224420 55 \$	PN1224430 75 \$	PN1224440 67 \$
14 mm	PN1424400 63 \$	PN1425003 42 \$	PN1424420 77 \$	PN1424430 105 \$	PN1424440 94 \$
20 mm	PN2024400 63 \$	PN2025003 42 \$	PN2024420 77 \$	PN2024430 105 \$	PN2024440 94 \$

Profix Kot N seramik, mermer ve tüm kaplamalarda farklı yüksekliklerdeki zemin yüzeyleri arasında geçişi sağlayan dekoratif görünümlü paslanmaz çelikten üretilen kot farklılık profilidir.

Seramik ,mermer ve tüm kaplamalarda farklı kotlardaki geçişi sağlayan 304 kalite paslanmaz çelikten üretilen kot farklılık profilidir.10 farklı renk alternatifi ile üretilmektedir. Renkli ürünler PVD teknolojisi ile paslanmaz yüzeye yüksek dayanıma sahip titanyum iyon kaplama yöntemi ile üretilmektedir.

Profix KOT N is stepless transition profile produced from 4301 grade stainless steel with offered 10 different surface colour options .All color options produced by PVD Technologies with high resistance titanium covered .

Inox (Satinox), Dekorlu (Decor), Inox Parlak (Shine) yüzeyler 250 cm boyda üretilmektedir. / Surfaces 250 cm length. Ayna (Mirror), Altın (Satine Gold), Altın ayna (Gold), Bakır (Satine bronze), Bakır Ayna (Bronze mirror),Antrasit (Satine Anthracite), Antrasit ayna (Anthracite mirror) yüzeyler 244 cm boyda üretilmektedir. / surfaces 244 cm length. Maximum boy 300 cm üretilmektedir. / Profile can be produced up to 300 cm. Paket içi adeti: 8 ADET / Products per box. Belirtilen hammadde kalınlıkları 0,80 mm dir, 0,60 mm için fiyat talep edilmelidir. Thickness is 0,80 mm. Should be request price for 0,60 mm alternatives.

TEKNİK ÖLÇÜ TABLOSU



	08 mm	10 mm	12 mm	14 mm	20 mm
W	30	30	30	30	30
H	9,5	11,5	13,5	15,5	21,5



Ebat size	Inox satinox	Altın s gold	Bakır Bronze	Antrasit s. anthracite
15 mm	PT1525001	26 \$ PT1524421	43 \$ PT1524431	57 \$ PT1524441
25 mm	PT2525001	34 \$ PT2524421	52 \$ PT2524431	65 \$ PT2524441

Ebat size	Inox Ayna mirror	Inox Parlak shine	Altın Ayna gold	Bakır Ayna bronze	Antrasit Ayna anthracite
15 mm	PT1524400	39 \$ PT1525003	26 \$ PT1524420	43 \$ PT1524430	57 \$ PT1524440
25 mm	PT2524400	46 \$ PT2525003	34 \$ PT2524420	52 \$ PT2524430	65 \$ PT2524440



Ebat size	Inox satinox	Altın s gold	Bakır Bronze	Antrasit s. anthracite
10 mm	PT1025001	39 \$ PT1024421	58 \$ PT1024431	75 \$ PT1024441
12 mm	PT1225001	39 \$ PT1224421	58 \$ PT1224431	75 \$ PT1224441
14 mm	PT1425001	39 \$ PT1424421	58 \$ PT1424431	75 \$ PT1424441

Ebat size	Inox Ayna mirror	Inox Parlak shine	Altın Ayna gold	Bakır Ayna bronze	Antrasit Ayna anthracite
10 mm	PT1024400	53 \$ PT1025003	39 \$ PT1024420	58 \$ PT1024430	75 \$ PT1024440
12 mm	PT1224400	53 \$ PT1225003	39 \$ PT1224420	58 \$ PT1224430	75 \$ PT1224440
14 mm	PT1424400	53 \$ PT1425003	39 \$ PT1424420	58 \$ PT1424430	75 \$ PT1424440

Inox (Satinox), Dekorlu (Decor), Inox Parlak (Shine) yüzeyler 250 cm boyda üretilmektedir. / Surfaces 250 cm lenght. Ayna (Mirror), Altın (Satine Gold), Altın ayna (Gold), Bakır (Satine bronze), Bakır Ayna (Bronze mirror), Antrasit (Satine Anthracite), Antrasit ayna (Anthracite mirror) yüzeyler 244 cm boyda üretilmektedir. / surfaces 244 cm lenght. Maximum boy 300 cm üretilmektedir. / Profile can be produced up to 300 cm. Paket içi adeti: 6 ADET / Products per box. Belirtilen hammadde kalınlıkları 0,80 mm dir, 0,60 mm için fiyat talep edilmelidir. Thickness is 0,80 mm. Should be request price for 0,60 mm alternatives.

TEKNİK ÖLÇÜ TABLOSU

		15 mm	25 mm
W	W	15	25
H	H	13	11

PROFIX G

TECHNOLINE

DİLATASYON PROFİLİ

P Dizayn

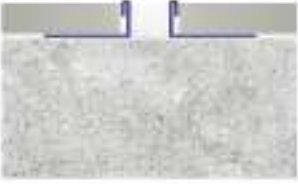
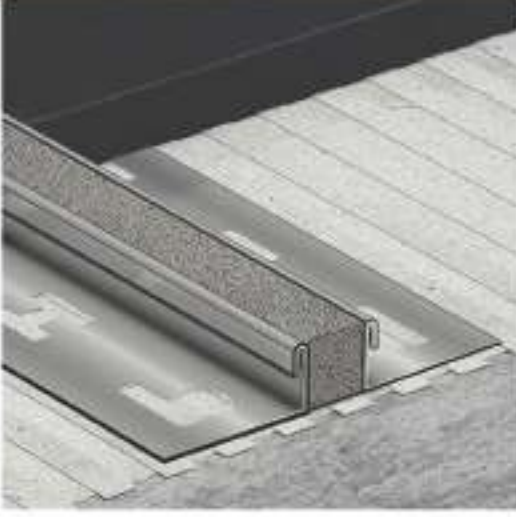

Ebat size	Inox satinox	
8 mm	PG0825001	62,5 \$
10 mm	PG1025001	65,0 \$
12 mm	PG1225001	67,5 \$
14 mm	PG1425001	70,0 \$

Profix G seramik kaplamalarda kullanılan her türlü hareket derzlerine uygun paslanmaz çelikten üretilen dilatasyon profilidir.

Seramik ,mermer ve tüm kaplamalarda farklı kotlardaki geçişi sağlayan 304 kalite paslanmaz çelikten üretilen kot farklılık profilidir.10 farklı renk alternatifini ile üretilmektedir. Renkli ürünler PVD teknolojisi ile paslanmaz yüzeye yüksek dayanıma sahip titanyum iyon kaplama yöntemi ile üretilmektedir.

Profix G is dilatation profile produced from 4301 grade stainless steel with offered 10 different surface colour options . All color options produced by PVD Technologies with high resistance titanium covered .

Inox (Satinox), Dekorlu (Decor), Inox Parlak (Shine) yüzeyler 250 cm boyda üretilmektedir. / Surfaces 250 cm length. Ayna (Mirror), Altın (Satine Gold), Altın ayna (Gold), Bakır (Satine bronze), Bakır Ayna (Bronze mirror),Antrasit (Satine Antracite), Antrasit ayna (Antracite mirror) yüzeyler 244 cm boyda üretilmektedir. / surfaces 244 cm length. Maximum boy 300 cm üretilmektedir. / Profile can be produced up to 300 cm. Paket içi adeti: 10 ADET / Products per box. Belirtilen hammadde kalınlıkları 0,80 mm dir, 0,60 mm için fiyat talep edilmelidir. Thickness is 0,80 mm. Should be request price for 0,60 mm alternatives.

TEKNİK ÖLÇÜ TABLOSU



	8 mm	10 mm	12 mm	14 mm
W	24,5	23,5	19,5	14,93
H	12	14	22	14,93

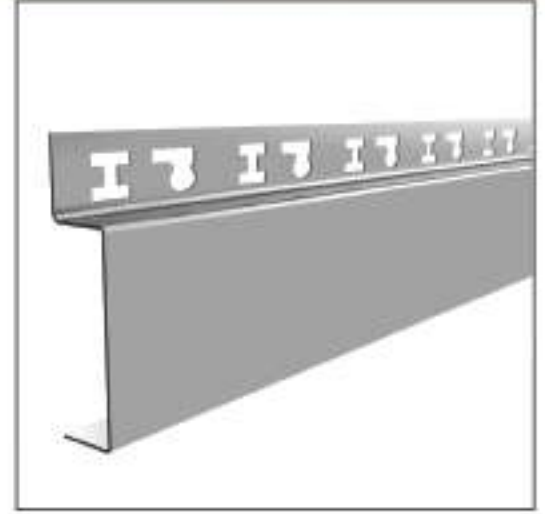
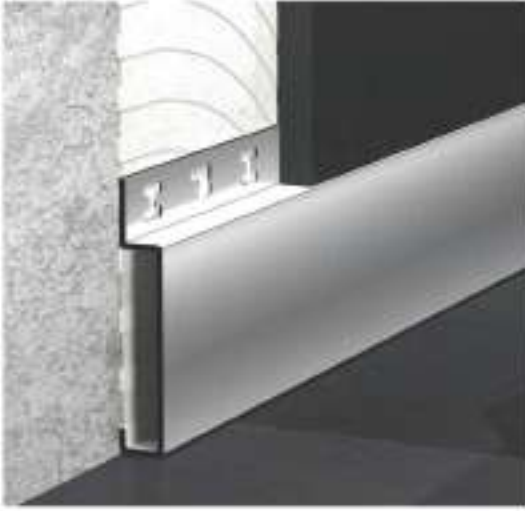

Ebat size	Inox satinox	Dekorlu decor	Altın s gold	Bakır s bronz	Antrasit s. anthracite
40/ 08 mm	PE1400825001	45 \$ PE1400825011	51 \$ PE1400824421	82 \$ PE1400824431	110 \$ PE1400824441
40/ 10 mm	PE1401025001	45 \$ PE1401025011	51 \$ PE1401024421	82 \$ PE1401024431	110 \$ PE1401024441
40/ 12 mm	PE1401225001	45 \$ PE1401225011	51 \$ PE1401224421	82 \$ PE1401224431	110 \$ PE1401224441
40/ 14 mm	PE1401425001	45 \$ PE1401425011	51 \$ PE1401424421	82 \$ PE1401424431	110 \$ PE1401424441

Ebat size	Inox Ayna mirror	Inox Parlak shine	Altın Ayna gold	Bakır Ayna bronz	Antrasit Ayna anthracite
40/ 08 mm	PE1400824403	58 \$ PE1400825003	45 \$ PE1400824420	82 \$ PE1400824430	110 \$ PE1400824440
40/ 10 mm	PE1401024403	58 \$ PE1401025003	45 \$ PE1401024420	82 \$ PE1401024430	110 \$ PE1401024440
40/ 12 mm	PE1401224403	58 \$ PE1401224403	45 \$ PE1401224420	82 \$ PE1401224430	110 \$ PE1401224440
40/ 14 mm	PE1401424403	58 \$ PE1401424403	45 \$ PE1401424420	82 \$ PE1401424430	110 \$ PE1401424440

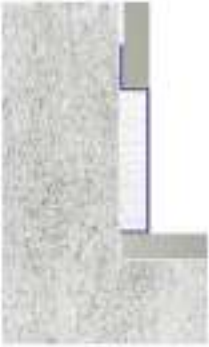

Ebat size	Inox satinox	Dekorlu decor	Altın s gold	Bakır s bronz	Antrasit s. anthracite
70/ 08 mm	PE1700825001	55 \$ PE1700825011	70 \$ PE1700824421	101 \$ PE1700824431	120 \$ PE1700824441
70/ 10 mm	PE1701025001	55 \$ PE1701025011	70 \$ PE1701024421	101 \$ PE1701024431	120 \$ PE1701024441
70/ 12 mm	PE1701225001	55 \$ PE1701225011	70 \$ PE1701224421	101 \$ PE1701224431	120 \$ PE1701224441
70/ 14 mm	PE1701425001	55 \$ PE1701425011	70 \$ PE1701424421	101 \$ PE1701424431	120 \$ PE1701424441

Ebat size	Inox Ayna mirror	Inox Parlak shine	Altın Ayna gold	Bakır Ayna bronz	Antrasit Ayna anthracite
70/ 08 mm	PE1700824400	70 \$ PE1700825003	55 \$ PE1700824420	101 \$ PE1700824430	120 \$ PE1700824440
70/ 10 mm	PE1701024400	70 \$ PE1701025003	55 \$ PE1701024420	101 \$ PE1701024430	120 \$ PE1701024440
70/ 12 mm	PE1701224400	70 \$ PE1701225003	55 \$ PE1701224420	101 \$ PE1701224430	120 \$ PE1701224440
70/ 14 mm	PE1701424400	70 \$ PE1701425003	55 \$ PE1701424420	101 \$ PE1701424430	120 \$ PE1701424440

Profix E1 seramik,mermer ve tüm kaplamalarda paslanmaz çelikten üretilen dekoratif görünümlü dahili süpürgelik profilidir. Seramik,mermer ve tüm kaplamalarda süpürgelik olarak kullanılan 304 kalite paslanmaz çelikten üretilen profildir.10 farklı renk alternatifi ile üretilmektedir. Renkli ürünler PVD teknolojisi ile paslanmaz yüzeye yüksek dayanıma sahip titanyum iyon kaplama yöntemi ile üretilmektedir.

Profix E1 is baseboard profile produced from 4301 grade stainless steel with offered 10 different surface color options. All colour options produced by PVD Technologies with high resistance titanium covered .

Inox (Satinox), Dekorlu (Decor), Inox Parlak (Shine) yüzeyler 250 cm boyda üretilmektedir. / Surfaces 250 cm length. Ayna (Mirror), Altın (Satine Gold), Altın ayna (Gold), Bakır (Satine bronz), Bakır Ayna (Bronze mirror),Antrasit (Satine Anthracite), Antrasit ayna (Anthracite mirror) yüzeyler 244 cm boyda üretilmektedir. / surfaces 244 cm length. Maximum boy 300 cm üretilmektedir. / Profile can be produced up to 300 cm. Paket içi adedi: 6 ADET / Products per box. Belirtilen hammadde kalınlıkları 0,80 mm dir, 0,60 mm için fiyat talep edilmelidir. Thickness is 0,80 mm. Should be request price for 0,60 mm alternatives.

TEKNİK ÖLÇÜ TABLOSU

	40/8 mm	40/10 mm	40/12 mm	40/14 mm	70/8 mm	70/10 mm	70/12 mm	70/14 mm
W	8	10	12	14	8	10	12	14
H	40	40	40	40	70	70	70	70

PROFIX Y

DAHİLİ İÇ
KÖŞE PROFİLİ

TECHNOLINE

P Dizayn

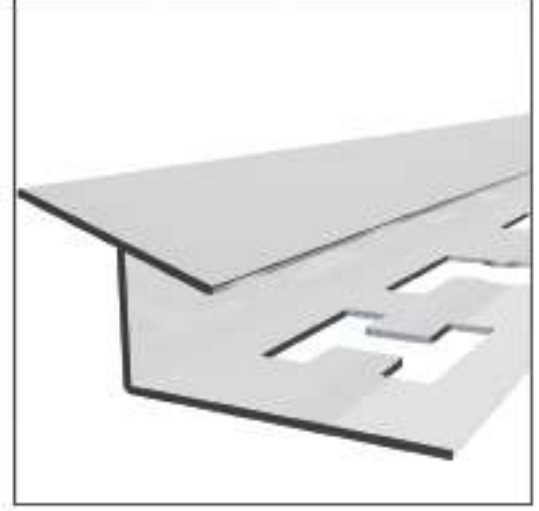

Ebat size	Inox satinox	Dekorlu decor	Altın s gold	Bakır s bronze	Antrasit s. anthracite
8 mm	PY0825001 39 \$	PY0825011 53 \$	PY0824421 58 \$	PY0824431 75 \$	PY0824441 75 \$
10 mm	PY1025001 39 \$	PY1025011 53 \$	PY1024421 58 \$	PY1024431 75 \$	PY1024441 75 \$
12 mm	PY1225001 39 \$	PY1225011 53 \$	PY1224421 58 \$	PY1224431 75 \$	PY1224441 75 \$
14 mm	PY1425001 39 \$	PY1425011 53 \$	PY1424421 58 \$	PY1424431 75 \$	PY1424441 75 \$

Ebat size	Inox Ayna mirror	Inox Parlak shine	Altın Ayna gold	Bakır Ayna bronze	Antrasit Ayna anthracite
8 mm	PY0824400 53 \$	PY0825003 39 \$	PY0824420 58 \$	PY0824430 75 \$	PY0824440 75 \$
10 mm	PY1024400 53 \$	PY1025003 39 \$	PY1024420 58 \$	PY1024430 75 \$	PY1024440 75 \$
12 mm	PY1224400 53 \$	PY1225003 39 \$	PY1224420 58 \$	PY1224430 75 \$	PY1224440 75 \$
14 mm	PY1424400 53 \$	PY1425003 39 \$	PY1424420 58 \$	PY1424430 75 \$	PY1424440 75 \$

Profix Y seramik yüzeylerin iç köşe ve birleşim noktaları için kullanılan dahili paslanmaz çelikten üretilen dekoratif görünümlü dahili iç köşe koruma profilidir.

Profix G is dilatation profile produced from 4301 grade stainless stell with offered 10 different surface colour options . All color options produced by PVD Technologies with high residence titanium covered .

Profix Y is inner corner edge profile produced from 4301 grade stainless stell with offered 10 different surface colour options.All colour options produced by PVD technologies with high residence titanium covered.

Inox (Satinox), Dekorlu (Decor), Inox Parlak (Shine) yüzeyler 250 cm boyda üretilmektedir. / Surfaces 250 cm lenght. Ayna (Mirror), Altın (Satine Gold), Altın ayna (Gold), Bakır (Satine bronze), Bakır Ayna (Bronze mirror),Antrasit (Satine Anthracite), Antrasit ayna (Anthracite mirror) yüzeyler 244 cm boyda üretilmektedir. / surfaces 244 cm lenght. Maximum boy 300 cm üretilmektedir. / Profile can be produced up to 300 cm. Paket içi adeti: 10 ADET / Products per box. Belirtilen hammadde kalınlıkları 0,80 mm dir, 0,60 mm için fiyat talep edilmelidir. Thickness is 0,80 mm. Should be request price for 0,60 mm alternatives.



TEKNİK ÖLÇÜ TABLOSU

	8 mm	10 mm	12 mm	14 mm
W	20	20	20	20
H	10	12	14	16



Ebat size	Inox satinox	
70 mm	PE27025001	45 \$

Ebat size	Inox Parlak shine	
70 mm	PE27025003	45 \$

Profix E2 seramik , mermer ve tüm kaplamalarda paslanmaz çelikten üretilen dekoratif görünümlü harici süpürgelik profilidir.Seramik ,mermer ve tüm kaplamalarda süpürgelik olarak kullanılan 304 kalite paslanmaz çelikten üretilen profildir.10 farklı renk alternatifi ile üretilmektedir. Renkli ürünler PVD teknolojisi ile paslanmaz yüzeye yüksek dayanıma sahip titanyum iyon kaplama yöntemi ile üretilmektedir. Profix E2 is baseboard profile produced from 4301 grade stainless stell with offered 10 different surface colour options. All colour options produced by PVD technologies with high residence titanium covered .

Inox (Satinox), Dekorlu (Decor), Inox Parlak (Shine) yüzeyler 250 cm boyda üretilmektedir. / Surfaces 250 cm lenght. Ayna (Mirror), Altın (Satine Gold), Altın ayna (Gold), Bakır (Satine bronze), Bakır Ayna (Bronze mirror),Antrasit (Satine Antracite), Antrasit ayna (Antracite mirror) yüzeyler 244 cm boyda üretilmektedir. / surfaces 244 cm lenght. Maximum boy 300 cm üretilmektedir. / Profile can be produced up to 300 cm. Paket içi adeti: 6 ADET / Products per box. Belirtilen hammadde kalınlıkları 0,80 mm dir, 0,60 mm için fiyat talep edilmelidir. Thickness is 0,80 mm. Should be request price for 0,60 mm alternatives.



TEKNİK ÖLÇÜ TABLOSU

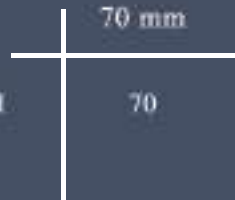

PROFIX E3

HAMİCİ SÜPÜRGELEK
PROFİLİ

TECHNOLINE

P Dizayn

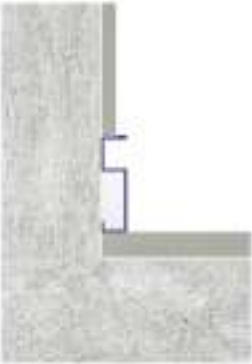

Ebat size	Inox satinox	Dekorlu decor	Altın s gold	Bakır s bronze	Antrasit s. anthracite
40/ 08 mm	PE3400825001	45 \$ PE3400825011	51 \$ PE3400824421	82 \$ PE3400824431	110 \$ PE3400824441
40/ 10 mm	PE3401025001	45 \$ PE3401025011	51 \$ PE3401024421	82 \$ PE3401024431	110 \$ PE3401024441
40/ 12 mm	PE3401225001	45 \$ PE3401225011	51 \$ PE3401224421	82 \$ PE3401224431	110 \$ PE3401224441
40/ 14 mm	PE3401425001	45 \$ PE3401425011	51 \$ PE3401424421	82 \$ PE3401424431	110 \$ PE3401424441

Ebat size	Inox Ayna mirror	Inox Parlak shine	Altın Ayna gold	Bakır Ayna bronze	Antrasit Ayna anthracite
40/ 08 mm	PE3400824400	58 \$ PE3400825003	45 \$ PE3400824420	82 \$ PE3400824430	110 \$ PE3400824440
40/ 10 mm	PE3401024400	58 \$ PE3401025003	45 \$ PE3401024420	82 \$ PE3401024430	110 \$ PE3401024440
40/ 12 mm	PE3401224400	58 \$ PE3401224403	45 \$ PE3401224420	82 \$ PE3401224430	110 \$ PE3401224440
40/ 14 mm	PE3401424400	58 \$ PE3401424403	45 \$ PE3401424420	82 \$ PE3401424430	110 \$ PE3401424440

Ebat size	Inox satinox	Dekorlu decor	Altın s gold	Bakır s bronze	Antrasit s. anthracite
70/ 08 mm	PE3700825001	55 \$ PE3700825011	70 \$ PE3700824421	101 \$ PE3700824431	120 \$ PE3700824441
70/ 10 mm	PE3701025001	55 \$ PE3701025011	70 \$ PE3701024421	101 \$ PE3701024431	120 \$ PE3701024441
70/ 12 mm	PE3701225001	55 \$ PE3701225011	70 \$ PE3701224421	101 \$ PE3701224431	120 \$ PE3701224441
70/ 14 mm	PE3701425001	55 \$ PE3701425011	70 \$ PE3701424421	101 \$ PE3701424431	120 \$ PE3701424441

Ebat size	Inox Ayna mirror	Inox Parlak shine	Altın Ayna gold	Bakır Ayna bronze	Antrasit Ayna anthracite
70/ 08 mm	PE3700824400	70 \$ PE3700825003	55 \$ PE3700824420	101 \$ PE3700824430	120 \$ PE3700824440
70/ 10 mm	PE3701024400	70 \$ PE3701025003	55 \$ PE3701024420	101 \$ PE3701024430	120 \$ PE3701024440
70/ 12 mm	PE3701224400	70 \$ PE3701225003	55 \$ PE3701224420	101 \$ PE3701224430	120 \$ PE3701224440
70/ 14 mm	PE3701424400	70 \$ PE3701425003	55 \$ PE3701424420	101 \$ PE3701424430	120 \$ PE3701424440

Profix E3 seramik, mermer ve tüm kaplamalarda paslanmaz çelikten üretilen dekoratif görünümlü süpürgelik profilidir. Seramik ,mermer ve tüm kaplamalarda süpürgelik olarak kullanılan 304 kalite paslanmaz çelikten üretilen profildir.10 farklı renk alternatifi ile üretilmektedir. Renkli ürünler PVD teknolojisi ile paslanmaz yüzeye yüksek dayanıma sahip titanyum iyon kaplama yöntemi ile üretilmektedir.

Profix E3 is baseboard profile produced from 4301 grade stainless steel with offered 10 different surface colour options. All colour options produced by PVD technologies with high resistance titanium covered .



TEKNİK ÖLÇÜ TABLOSU

	40/8 mm	40/10 mm	40/12 mm	40/14 mm	70/8 mm	70/10 mm	70/12 mm	70/14 mm
W	8	10	12	14	8	10	12	14
H	40	40	40	40	70	70	70	70

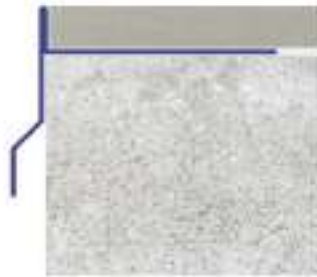

Ebat size	Inox satinox	
10 mm	PE41025001	55 \$
12 mm	PE41225001	56 \$
20 mm	PE42025001	57 \$

Ebat size	Inox Parlak shine	
10 mm	PE41025003	55 \$
12 mm	PE41225003	56 \$
20 mm	PE42025003	57 \$

Profix E4 seramik, mermer ve tüm kaplamalarda damlalık olarak kullanılan dekoratif görünümlü paslanmaz çelikten üretilen dahili damlalık profilidir. Seramik, mermer ve tüm kaplamalarda damlalık kullanılan 304 kalite paslanmaz çelikten üretilen damlalık profilidir. 10 farklı renk alternatifini ile üretilmektedir. Renkli ürünler PVD teknolojisi ile paslanmaz yüzeye yüksek dayanıma sahip titanyum iyon kaplama yöntemi ile üretilmektedir. Profix E4 is internal drip profile produced from 4301 grade stainless steel with offered 10 different surface colour options. All colour options produced by PVD technologies with high resistance titanium covered .

Inox (Satinox), Dekorlu (Decor), Inox Parlak (Shine) yüzeyler 250 cm boyda üretilmektedir. / Surfaces 250 cm length. Ayna (Mirror), Altın (Satine Gold), Altın ayna (Gold), Bakır (Satine bronze), Bakır Ayna (Bronze mirror), Antrasit (Satine Antracite), Antrasit ayna (Antracite mirror) yüzeyler 244 cm boyda üretilmektedir. / surfaces 244 cm length. Maximum boy 300 cm üretilmektedir. / Profile can be produced up to 300 cm. Paket içi adeti: 6 ADET / Products per box. Belirtilen hammadde kalınlıkları 0,80 mm dir, 0,60 mm için fiyat talep edilmelidir. Thickness is 0,80 mm. Should be request price for 0,60 mm alternatives.

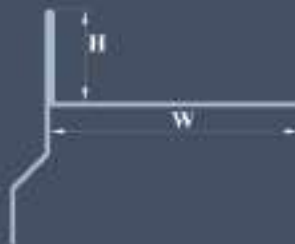

TEKNİK ÖLÇÜ TABLOSU

	10 mm	12 mm	14 mm
W	47	45	43
H	12	14	16

PROFIX KOT A

MARKET KOT PROFİLİ

TECHNOLINE

P Dizayn

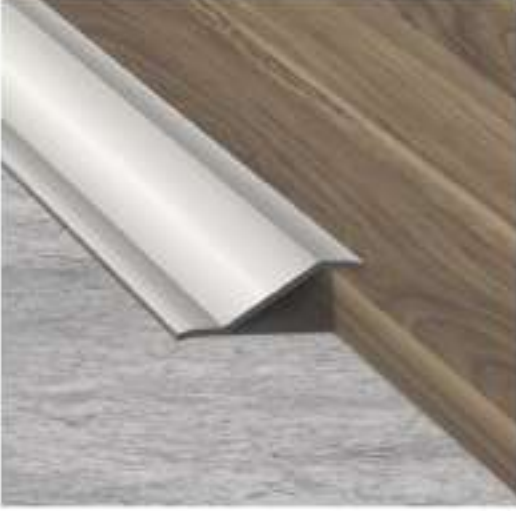

Ebat size	Inox satinox	
8 mm	PKA0825001	23,0 \$
10 mm	PKA1025001	23,5 \$
12 mm	PKA1225001	24,0 \$
14 mm	PKA1425001	24,5 \$
20 mm	PKA2025001	27,0 \$

Ebat size	Inox Parlak shine	
8 mm	PKA0825003	23,0 \$
10 mm	PKA1025003	23,5 \$
12 mm	PKA1225003	24,0 \$
14 mm	PKA1425003	24,5 \$
20 mm	PKA2025003	27,0 \$

Profix Kot A seramik, mermer ve tüm kaplamalarda farklı yüksekliklerdeki zemin yüzeyleri arasında geçişi sağlayan dekoratif görünümlü paslanmaz çelikten üretilen kot farklılık profilidir.

Seramik, mermer ve tüm kaplamalarda farklı kotlardaki geçişi sağlayan 304 kalite paslanmaz çelikten üretilen kot farklılık profilidir. 10 farklı renk alternatifi ile üretilmektedir. Renkli ürünler PVD teknolojisi ile paslanmaz yüzeye yüksek dayanıma sahip titanyum iyon kaplama yöntemi ile üretilmektedir.

Profix KOT A is stepless transition profile produced from 4301 grade stainless steel with offered 10 different surface colour options. All colour options produced by PVD technologies with high resistance titanium covered.

Inox (Satinox), Dekorlu (Decor), Inox Parlak (Shine) yüzeyler 250 cm boyda üretilmektedir. / Surfaces 250 cm length. Ayna (Mirror), Altın (Satine Gold), Altın ayna (Gold), Bakır (Satine bronze), Bakır Ayna (Bronze mirror), Antrasit (Satine Antracite), Antrasit ayna (Antracite mirror) yüzeyler 244 cm boyda üretilmektedir. / surfaces 244 cm length. Maximum boy 300 cm üretilmektedir. / Profile can be produced up to 300 cm. Paket içi adeti: 8 ADET / Products per box. Belirtilen hammadde kalınlıkları 0,80 mm dir, 0,60 mm için fiyat talep edilmelidir. Thickness is 0,80 mm. Should be request price for 0,60 mm alternatives.



TEKNİK ÖLÇÜ TABLOSU

	8 mm	10 mm	12 mm	14 mm
W	6	6	6	6
H	10	12	14	16

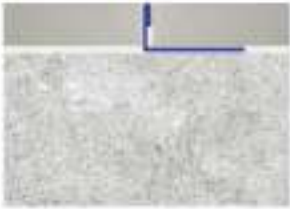
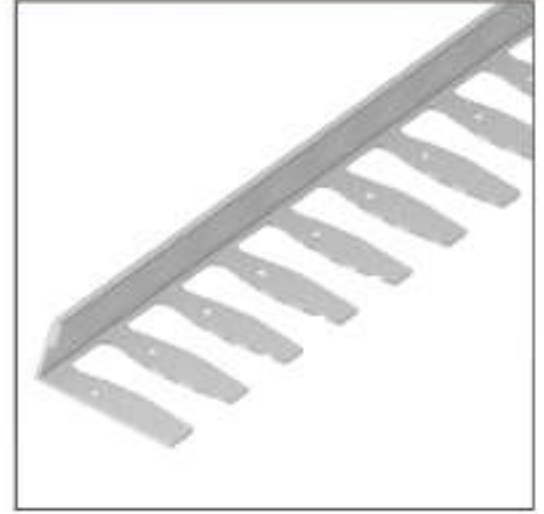
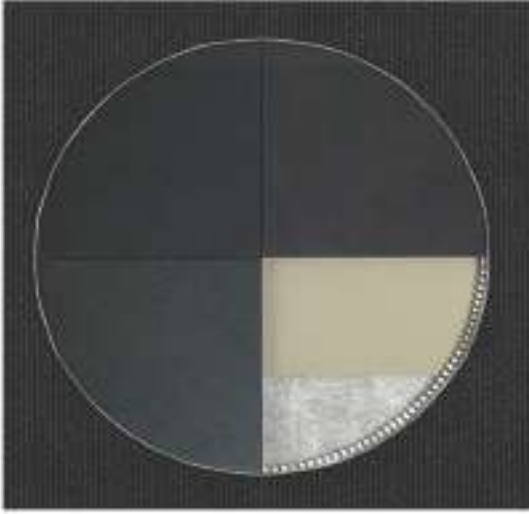

Ebat size	Inox satinox	Altın s gold	Bakır s bronze	Antrasit s. anthracite
8 mm	PLR0825001 26,0 \$	PLR0824421 44,5 \$	PLR0824431 54,5 \$	PLR0824441 54,5 \$
10 mm	PLR1025001 26,5 \$	PLR1024421 45,0 \$	PLR1024431 55,0 \$	PLR1024441 55,0 \$
12 mm	PLR1225001 27,0 \$	PLR1224421 45,5 \$	PLR1224431 55,5 \$	PLR1224441 55,5 \$
14 mm	PLR1425001 27,5 \$	PLR1424421 46,0 \$	PLR1424431 56,0 \$	PLR1424441 56,0 \$

Ebat size	Inox Ayna mirror	Inox Parlak shine	Altın Ayna gold	Bakır Ayna bronze	Antrasit Ayna anthracite
8 mm	PLR0824400 35,0 \$	PLR0825003 26,0 \$	PLR0824420 44,5 \$	PLR0824430 54,5 \$	PLR0824440 54,5 \$
10 mm	PLR1024400 35,5 \$	PLR1025003 26,5 \$	PLR1024420 45,0 \$	PLR1024430 55,0 \$	PLR1024440 55,0 \$
12 mm	PLR1224400 36,0 \$	PLR1225003 27,0 \$	PLR1224420 45,5 \$	PLR1224430 55,5 \$	PLR1224440 55,5 \$
14 mm	PLR1424400 36,5 \$	PLR1425003 27,5 \$	PLR1424420 46,0 \$	PLR1424430 56,0 \$	PLR1424440 56,0 \$

Profix LR seramik yüzeylerin dış köşelerini korumak amacıyla kullanılan dekoratif görünümlü paslanmaz çelikten üretilen LR dış kenar bitiş profilidir. Seramik yüzeylerin dış köşelerini korumak için 304 kalite paslanmaz çelikten üretilen LR dış kenar bitiş profilidir. 10 farklı renk alternatifi ile üretilmektedir. Renkli ürünler PVD teknolojisi ile paslanmaz yüzeye yüksek dayanıma sahip titanyum iyon kaplama yöntemi ile üretilmektedir. Profix LR is shape outer edge profile produced from 4301 grade stainless steel with offered 10 different surface colour options. All colour options produced by PVD technologies with high resistance titanium covered.

Inox (Satinox), Dekorlu (Decor), Inox Parlak (Shine) yüzeyler 250 cm boyda üretilmektedir. / Surfaces 250 cm length. Ayna (Mirror), Altın (Satine Gold), Altın ayna (Gold), Bakır (Satine bronze), Bakır Ayna (Bronze mirror), Antrasit (Satine Anthracite), Antrasit ayna (Anthracite mirror) yüzeyler 244 cm boyda üretilmektedir. / surfaces 244 cm length. Maximum boy 300 cm üretilmektedir. / Profile can be produced up to 300 cm. Paket içi adeti: 6 ADET / Products per box. Belirtilen hammadde kalınlıkları 0,80 mm dir, 0,60 mm için fiyat talep edilmelidir. Thickness is 0,80 mm. Should be request price for 0,60 mm alternatives.



TEKNİK ÖLÇÜ TABLOSU

	8 mm	10 mm	12 mm	14 mm
W	2,13	2,58	3,03	3,48
H	9,5	11,5	13,5	15,5

PROFIX B

TECHNOLINE

FUGA PROFİLİ

R Dizayn

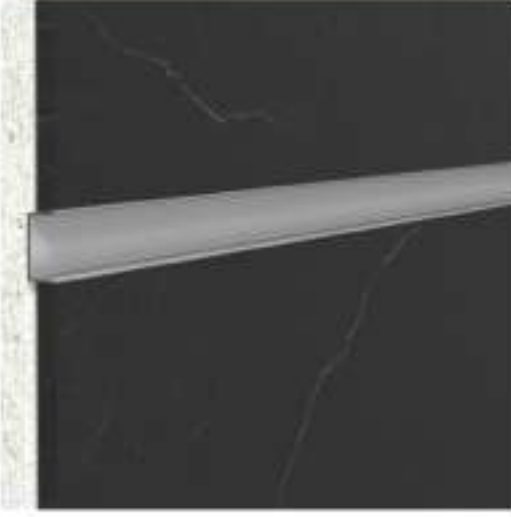

Ebat size	Inox satinox	Dekorlu decor	Altın s gold	Bakır s bronze	Antrasit s. anthracite
15 mm	PBB1525001	23 \$ PBB1525011	29 \$ PBB1524421	35 \$ PBB1524431	40 \$ PBB1524441
23 mm	PBB2325001	26 \$ PBB2325011	32 \$ PBB2324421	38 \$ PBB2324431	43 \$ PBB2324441
30 mm	PBB3025001	28 \$ PBB3025011	34 \$ PBB3024421	40 \$ PBB3024431	46 \$ PBB3024441

Ebat size	Inox Ayna mirror	Inox Parlak shine	Altın Ayna gold	Bakır Ayna bronze	Antrasit Ayna anthracite
15 mm	PBB1524400	29 \$ PBB1525003	23 \$ PBB1524420	35 \$ PBB1524430	40 \$ PBB1524440
23 mm	PBB2324400	32 \$ PBB2325003	26 \$ PBB2324420	38 \$ PBB2324430	43 \$ PBB2324440
30 mm	PBB3024400	34 \$ PBB3025003	28 \$ PBB3024420	40 \$ PBB3024430	46 \$ PBB3024440

Profix B seramik,mermer ve tüm kaplamalarda bordür olarak kullanılan dekoratif görünümlü paslanmaz çelikten üretilen fuga profilidir. Seramik ,mermer ve tüm kaplamalarda bordür amaçlı kullanılan 304 kalite paslanmaz çelikten üretilen fuga profilidir.10 farklı renk alternatif ile üretilmektedir. Renkli ürünler PVD teknolojisi ile paslanmaz yüzeye yüksek dayanıma sahip titanyum iyon kaplama yöntemi ile üretilmektedir. Profix B is fuga profile produced from 4301 grade stainless stell with offered 10 different surface colour options.All colour options produced by PVD technologies with high residence titanium covered .

Inox (Satinox), Dekorlu (Decor), Inox Parlak (Shine) yüzeyler 250 cm boyda üretilmektedir. / Surfaces 250 cm lenght. Ayna (Mirror), Altın (Satine Gold), Altın ayna (Gold), Bakır (Satine bronze), Bakır Ayna (Bronze mirror),Antrasit (Satine Anthracite), Antrasit ayna (Anthracite mirror) yüzeyler 244 cm boyda üretilmektedir. / surfaces 244 cm lenght. Maximum boy 300 cm üretilmektedir. / Profile can be produced up to 300 cm. Paket içi adeti: 10 ADET / Products per box. Belirtilen hammadde kalınlıkları 0,80 mm dir, 0,60 mm için fiyat talep edilmelidir. Thickness is 0,80 mm. Should be request price for 0,60 mm alternatives.



TEKNİK ÖLÇÜ TABLOSU

	15 mm	23 mm	30 mm
W	15	23	30
H	10	10	10

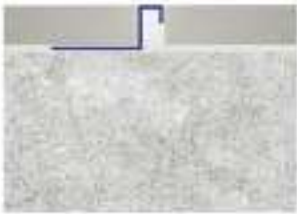

Ebat size	Inox satinox	Dekorlu decor	Altın s gold	Bakır s bronz	Antrasit s. anthracite					
8 mm	PBBB0825001	22,5 \$	PBBB0825011	31,0 \$	PBBB0824421	30,5 \$	PBBB0824431	42,0 \$	PBBB0824441	42,0 \$
10 mm	PBBB1025001	23,0 \$	PBBB1025011	31,5 \$	PBBB1024421	31,0 \$	PBBB1024431	42,5 \$	PBBB1024441	42,5 \$
12 mm	PBBB1225001	23,5 \$	PBBB1225011	32,0 \$	PBBB1224421	31,5 \$	PBBB1224431	43,0 \$	PBBB1224441	43,0 \$
14 mm	PBBB1425001	24,0 \$	PBBB1425011	32,5 \$	PBBB1424421	32,0 \$	PBBB1424431	43,5 \$	PBBB1424441	43,5 \$
Ebat size	Inox Ayna mirror	Inox Parlak shine	Altın Ayna gold	Bakır Ayna bronz	Antrasit Ayna anthracite					
8 mm	PBBB0824400	26,5 \$	PBBB0825003	22,5 \$	PBBB0824420	30,5 \$	PBBB0824430	42,0 \$	PBBB0824440	42,0 \$
10 mm	PBBB1024400	27,0 \$	PBBB1025003	23,0 \$	PBBB1024420	31,0 \$	PBBB1024430	42,5 \$	PBBB1024440	42,5 \$
12 mm	PBBB1224400	27,5 \$	PBBB1225003	23,5 \$	PBBB1224420	31,5 \$	PBBB1224430	43,0 \$	PBBB1224440	43,0 \$
14 mm	PBBB1424400	28,0 \$	PBBB1425003	24,0 \$	PBBB1424420	32,0 \$	PBBB1424430	43,5 \$	PBBB1424440	43,5 \$

Profix BB seramik, mermer ve tüm kaplamalarda bordür olarak kullanılan dekoratif görünümlü paslanmaz çelikten üretilen fuga profilidir. Seramik, mermer ve tüm kaplamalarda bordür amaçlı kullanılan 304 kalite paslanmaz çelikten üretilen fuga profilidir. 10 farklı renk alternatifi ile üretilmektedir. Renkli ürünler PVD teknolojisi ile paslanmaz yüzeye yüksek dayanıma sahip titanyum iyon kaplama yöntemi ile üretilmektedir. Profix BB is Fuga profile produced from 4301 grade stainless steel with offered 10 different surface colour options. All colour options produced by PVD technologies with high resistance titanium covered.

Inox (Satinox), Dekorlu (Decor), Inox Parlak (Shine) yüzeyler 250 cm boyda üretilmektedir. / Surfaces 250 cm length. Ayna (Mirror), Altın (Satine Gold), Altın ayna (Gold), Bakır (Satine bronz), Bakır Ayna (Bronze mirror), Antrasit (Satine Antracite), Antrasit ayna (Anthracite mirror) yüzeyler 244 cm boyda üretilmektedir. / surfaces 244 cm length. Maximum boy 300 cm üretilmektedir. / Profile can be produced up to 300 cm. Paket içi adeti: 6 ADET / Products per box. Belirtilen hammadde kalınlıkları 0,80 mm dir, 0,60 mm için fiyat talep edilmelidir. Thickness is 0,80 mm. Should be request price for 0,60 mm alternatives.

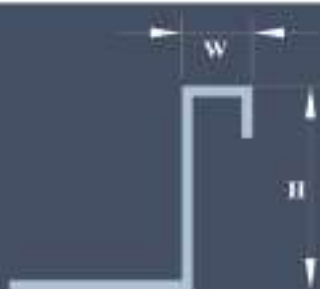

TEKNİK ÖLÇÜ TABLOSU

	8 mm	10 mm	12 mm	14 mm
W	5,5	5,5	5,5	5,5
H	10	12	14	16



Ebat size	Inox satinox	Dekorlu decor	Altın s gold	Bakır s bronze	Antrasit s. anthracite
10 mm	PQA1025001 26,5 \$	PQA1025011 35,5 \$	PQA1024421 45,5 \$	PQA1024431 55,0 \$	PQA1024441 55,0 \$
12 mm	PQA1225001 27,0 \$	PQA1225011 36,0 \$	PQA1224421 46,0 \$	PQA1224431 55,5 \$	PQA1224441 55,5 \$
14 mm	PQA1425001 27,5 \$	PQA1425011 36,5 \$	PQA1424421 46,5 \$	PQA1424431 56,0 \$	PQA1424441 56,0 \$

Ebat size	Inox Ayna mirror	Inox Parlak shine	Altın Ayna gold	Bakır Ayna bronze	Antrasit Ayna anthracite
10 mm	PQA1024400 35,5 \$	PQA1025003 26,5 \$	PQA1024420 45,5 \$	PQA1024430 55,0 \$	PQA1024440 55,0 \$
12 mm	PQA1224400 36,0 \$	PQA1225003 27,0 \$	PQA1224420 46,0 \$	PQA1224430 55,5 \$	PQA1224440 55,5 \$
14 mm	PQA1424400 36,5 \$	PQA1425003 27,5 \$	PQA1424420 46,5 \$	PQA1424430 56,0 \$	PQA1424440 56,0 \$

Profix QA seramik, mermer ve tüm kaplamalarda açılı köşe birleşimi olarak kullanılan dekoratif görünümlü paslanmaz çelikten üretilen açılı köşe profilidir.

Seramik,mermer ve tüm kaplamalarda 304 kalite paslanmaz çelikten üretilen açılı köşe profilidir.10 farklı renk alternatifi ile üretilmektedir. Renkli ürünler PVD teknolojisi ile paslanmaz yüzeye yüksek dayanıma sahip titanyum iyon kaplama yöntemi ile üretilmektedir.

Profix QA is angle corner profile produced from 4301 grade stainless steel with offered 10 different surface colour options. All colour options produced by PVD technologies with high resistance titanium covered.

Inox (Satinox), Dekorlu (Decor), Inox Parlak (Shine) yüzeyler 250 cm boyda üretilmektedir. / Surfaces 250 cm lenght. Ayna (Mirror), Altın (Satine Gold), Altın ayna (Gold), Bakır (Satine bronze), Bakır Ayna (Bronze mirror),Antrasit (Satine Anthracite), Antrasit ayna (Anthracite mirror) yüzeyler 244 cm boyda üretilmektedir. / surfaces 244 cm lenght. Maximum boy 300 cm üretilmektedir. / Profile can be produced up to 300 cm. Paket içi adeti: 10 ADET / Products per box. Belirtilen hammadde kalınlıkları 0,80 mm dir, 0,60 mm için fiyat talep edilmelidir. Thickness is 0,80 mm. Should be request price for 0,60 mm alternatives.

TEKNİK ÖLÇÜ TABLOSU

	10 mm	12 mm	14 mm
W	12	12	12
H	12	14	16



Ebat size	Inox satinox	Dekorlu decor	Altın s gold	Bakır s bronze	Antrasit s. anthracite
8 mm	PDK0825001 22,5 \$	PDK0825011 30,0 \$	PDK0824421 35,0 \$	PDK0824431 44,5 \$	PDK0824441 44,5 \$
10 mm	PDK1025001 23,0 \$	PDK1025011 30,5 \$	PDK1024421 35,5 \$	PDK1024431 45,0 \$	PDK1024441 45,0 \$
12 mm	PDK1225001 23,5 \$	PDK1225011 31,0 \$	PDK1224421 36,0 \$	PDK1224431 45,5 \$	PDK1224441 45,5 \$
14 mm	PDK1425001 24,0 \$	PDK1425011 31,5 \$	PDK1424421 36,5 \$	PDK1424431 46,0 \$	PDK1424441 46,0 \$

Ebat size	Inox Ayna mirror	Inox Parlak shine	Altın Ayna gold	Bakır Ayna bronze	Antrasit Ayna anthracite
8 mm	PDK0824400 30,0 \$	PDK0825003 22,5 \$	PDK0824420 35,0 \$	PDK0824430 44,5 \$	PDK0824440 44,5 \$
10 mm	PDK1024400 30,5 \$	PDK1025003 23,0 \$	PDK1024420 35,5 \$	PDK1024430 45,0 \$	PDK1024440 45,0 \$
12 mm	PDK1224400 31,0 \$	PDK1225003 23,5 \$	PDK1224420 36,0 \$	PDK1224430 45,5 \$	PDK1224440 45,5 \$
14 mm	PDK1424400 31,5 \$	PDK1425003 24,0 \$	PDK1424420 36,5 \$	PDK1424430 46,0 \$	PDK1424440 46,0 \$

Profix DK seramik duvar kağıdı geçişinde kullanılan duvar kağıdı kot geçiş profilidir. Seramik, mermer duvar kağıdı geçiş noktasında kullanılan 304 kalitede paslanmaz çelikten üretilen duvar kağıdı kot geçiş profilidir. Profix DK is internal drip profile produced from 4301 grade stainless steel with offered 10 different surface colour options. All colour options produced by PVD Technologies with high resistance titanium covered.

Inox (Satinox), Dekorlu (Decor), Inox Parlak (Shine) yüzeyler 250 cm boyda üretilmektedir. / Surfaces 250 cm length. Ayna (Mirror), Altın (Satine Gold), Altın ayna (Gold), Bakır (Satine bronze), Bakır Ayna (Bronze mirror), Antrasit (Satine Anthracite), Antrasit ayna (Anthracite mirror) yüzeyler 244 cm boyda üretilmektedir. / surfaces 244 cm length. Maximum boy 300 cm üretilmektedir. / Profile can be produced up to 300 cm. Paket içi adeti: 6 ADET / Products per box. Belirtilen hammadde kalınlıkları 0,80 mm dir, 0,60 mm için fiyat talep edilmelidir. Thickness is 0,80 mm. Should be request price for 0,60 mm alternatives.

TEKNİK ÖLÇÜ TABLOSU



	8 mm	10 mm	12 mm	14 mm
W	14,14	15,62	17,2	18,87
H	10	12	14	16

PROFILINE



Paslanmaz Çelik Dekoratif Profil

Profiline serisi ürünler sertifikalı 304 kalite paslanmaz çelikten üretilmektedir. Ürünün 10 farklı yüzey alternatifi (Inox, Inox Ayna, Inox Parlak, Dekorlu, Altın, Altın Ayna, Bakır, Bakır Ayna, Antrasit, Antrasit Ayna) mevcuttur. Renkli olan ürünler paslanmaz yüzeye pvd kaplama teknolojisi ile üretilmiştir.

Stainless Steel Decorative Profile

DECORATIVE BORDER PROFILES are manufactured from 1st grade 304 stainless steel, has 10 different surface alternatives. Profiline offered with 10,15,23,30,48 mm surface width and produced with 10 mm thickness. Lengths are 244 cm, 250 cm,270 cm. Length are very according to surfaces alternatives.

Islak mekanlarınıza değer katan zarif detaylar.
Çeliğin asil dokusu banyo ve mutfaklarınız da
Profiline Linear serisi ile yeni bir anlam kazanıyor.



Linear serisi ürünler sertifikalı 304 kalite paslanmaz çelikten üretilmektedir. Ürünün 10 farklı yüzey renk alternatifi (Inox, Inox Ayna,Inox Parlak Dekorlu, Altın, Altın Ayna, Bakır, Bakır Ayna, Antrasit, Antrasit Ayna) mevcuttur. Renkli olan ürünler paslanmaz yüzeye pvd kaplama teknolojisi ile üretilmiştir. Ürünün 5 farklı yüzey genişlik alternatifi mevcuttur.(10 mm, 15 mm, 23 mm, 30 mm, 48 mm)

Decorative border profiles are manufactured from 1st grade 304 stainless steel. Profiline offered with 10, 15, 23, 30, 48 mm surface width and produced with 10 mm thickness. Lengths are 244 mm, 250 mm, 270 cm. Length are very according to surface alternatives.Profiline has 10 different surface alternatives. Colored surface are titanium coated.

Ebat size	Inox satinox	Dekorlu decor	Altın s gold	Bakır s bronz	Antrasit s. anthracite
1 cm	PB1025001 14,0 \$	PB1025011 20,4 \$	PB1024421 19,5 \$	PB1024431 25,0 \$	PB1024441 25,0 \$
1.5 cm	PB1525001 15,5 \$	PB1525011 21,0 \$	PB1524421 23,5 \$	PB1524431 30,0 \$	PB1524441 30,0 \$
2.3 cm	PB2325001 18,0 \$	PB2325011 25,3 \$	PB2324421 26,0 \$	PB2324431 32,5 \$	PB2324441 32,5 \$
3 cm	PB3025001 20,0 \$	PB3025011 28,4 \$	PB3024421 30,0 \$	PB3024431 36,5 \$	PB3024441 36,5 \$
4.8 cm	PB4825001 26,5 \$	PB4825011 36,3 \$	PB4824421 40,0 \$	PB4824431 45,0 \$	PB4824441 45,0 \$

Ebat size	Inox Ayna mirror	Inox Parlak shine	Altın Ayna gold	Bakır Ayna bronz	Antrasit Ayna anthracite
1 cm	PB1024400 16,5 \$	PB1025003 14,0 \$	PB1024420 19,5 \$	PB1024430 25,0 \$	PB1024440 25,0 \$
1.5 cm	PB1524400 18,5 \$	PB1525003 15,5 \$	PB1524420 23,5 \$	PB1524430 30,0 \$	PB1524440 30,0 \$
2.3 cm	PB2324400 21,0 \$	PB2325003 18,0 \$	PB2324420 26,0 \$	PB2324430 32,5 \$	PB2324440 32,5 \$
3 cm	PB3024400 25,0 \$	PB3025003 20,0 \$	PB3024420 30,0 \$	PB3024430 36,5 \$	PB3024440 36,5 \$
4.8 cm	PB4824400 32,0 \$	PB4825003 26,5 \$	PB4824420 40,0 \$	PB4824430 45,0 \$	PB4824440 45,0 \$

Profiline Inox - Dekorlu = 250 cm / Inox Parlak = 250 cm / Altın-Altın Ayna = 244 cm / Bakır-Bakır Ayna = 244 cm / Antrasit-Antrasit Ayna = 244 cm

MADE WITH SWAROVSKI® ELEMENTS

Islak mekanlarınıza değer katan zarif detaylar.
Çeliğin asil dokusu banyo ve mutfaklarınız da
Profiline Linear serisi ile yeni bir anlam kazanıyor.



Linear E serisi ürünler sertifikalı 304 kalite paslanmaz çelikten üretilmektedir. Ürünün 10 farklı yüzey renk alternatifi (Inox, Inox Ayna,Inox Parlak Dekorlu, Altın, Altın Ayna, Bakır, Bakır Ayna, Antrasit, Antrasit Ayna) mevcuttur. Renkli olan ürünler paslanmaz yüzeye pvd kaplama teknolojisi ile üretilmiştir. Ürünün 5 farklı yüzey genişlik alternatifi mevcuttur.(10 mm, 15 mm, 23 mm, 30 mm, 48 mm)

Decorative border profiles are manufactured from 1st grade 304 stainless steel. Profiline offered with 10, 15, 23, 30, 48 mm surface width and produced with 10 mm thickness. Lengths are 244 mm, 250 mm, 270 cm. Length are very according to surface alternatives. Profiline has 10 different surface alternatives. Colored surface are titanium coated.

Ebat size	Inox satinox	Dekorlu decor	Altın s gold	Bakır s bronze	Antrasit s. anthracite
1 cm	KB1025001 10,9 \$	KB1025011 11,3 \$	KB1024421 13,8 \$	KB1024431 15,3 \$	KB1024441 15,3 \$
1.5 cm	KB1525001 11,0 \$	KB1525011 11,5 \$	KB1524421 14,0 \$	KB1524431 15,5 \$	KB1524441 15,5 \$
2 cm	KB2025001 13,3 \$	KB2025011 14,0 \$	KB2024421 16,8 \$	KB2024431 18,8 \$	KB2024441 18,8 \$
2.3 cm	KB2325001 13,5 \$	KB2325011 14,2 \$	KB2324421 17,0 \$	KB2324431 19,0 \$	KB2324441 19,0 \$
3 cm	KB3025001 16,0 \$	KB3025011 16,6 \$	KB3024421 20,0 \$	KB3024431 23,0 \$	KB3024441 23,0 \$
4.8 cm	KB4825001 21,5 \$	KB4825011 23,2 \$	KB4824421 27,0 \$	KB4824431 31,0 \$	KB4824441 31,0 \$

Ebat size	Inox Ayna mirror	Inox Parlak shine	Altın Ayna gold	Bakır Ayna bronze	Antrasit Ayna anthracite
1 cm	KB1024400 11,9 \$	KB1025003 10,9 \$	KB1024420 13,8 \$	KB1024430 15,3 \$	KB1024440 15,3 \$
1.5 cm	KB1524400 12,0 \$	KB1525003 11,0 \$	KB1524420 14,0 \$	KB1524430 15,5 \$	KB1524440 15,5 \$
2 cm	KB2024400 14,8 \$	KB2025003 13,3 \$	KB2024420 16,8 \$	KB2024430 18,8 \$	KB2024440 18,8 \$
2.3 cm	KB2324400 15,0 \$	KB2325003 13,5 \$	KB2324420 17,0 \$	KB2324430 19,0 \$	KB2324440 19,0 \$
3 cm	KB3024400 17,5 \$	KB3025003 16,0 \$	KB3024420 20,0 \$	KB3024430 23,0 \$	KB3024440 23,0 \$
4.8 cm	KB4824400 24,0 \$	KB4825003 21,5 \$	KB4824420 27,0 \$	KB4824430 31,0 \$	KB4824440 31,0 \$

Profiline Inox - Dekorlu = 250 cm / Inox Parlak = 250 cm / Altın-Altın Ayna = 244 cm / Bakır-Bakır Ayna = 244 cm / Antrasit-Antrasit Ayna = 244 cm

MADE WITH SWAROVSKI® ELEMENTS
0,6 mm kalınlık / 0,6 mm thickness

Swarovski kristalleri kullanılarak üretilen mekanlarda fark yaratan bir dekoratif bordür tasarımı **Diamond X**,



Diamond X serisi ürünler Made with SWAROVSKI® ELEMENTS kristalleri kullanılarak, 304 kalite paslanmaz çelikten üretilmektedir. Ürünün 10 farklı yüzey renk alternatifi (Inox, Inox Ayna, Inox Parlak, Dekorlu, Altın, Altın Ayna, Bakır, Bakır Ayna, Antrasit, Antrasit Ayna) mevcuttur. Renkli olan ürünler paslanmaz yüzeye pvd kaplama teknolojisi ile üretilmiştir. Ürünün 5 farklı yüzey genişlik alternatifi mevcuttur. (10 mm, 15 mm, 23 mm, 30 mm, 48 mm)

Decorative border profiles are manufactured from 1st grade 304 stainless steel. Profiline offered with 10, 15, 23, 30, 48 mm surface width and produced with 10 mm thickness. Lengths are 244 mm, 250 mm, 270 cm. Length are very according to surface alternatives. Profiline has 10 different surface alternatives. Colored surface are titanium coated. Diamond X MADE WITH SWAROVSKI® ELEMENTS.

Ebat Size	Inox Satinox	Dekorlu Decor	Altın S. Gold	Bakır S. Bronze	Antrasit S. Anthracite
1 cm	PB10250011 55,5 \$	PB10250111 83,6 \$	PB10244211 70,0 \$	PB10244311 95,2 \$	PB10244411 93,1 \$
1.5 cm	PB15250011 59,6 \$	PB15250111 92,2 \$	PB15244211 76,1 \$	PB15244311 105,5 \$	PB15244411 103,2 \$
2.3 cm	PB23250011 64,2 \$	PB23250111 98,8 \$	PB23244211 81,7 \$	PB23244311 115,7 \$	PB23244411 113,0 \$
3 cm	PB30250011 72,3 \$	PB30250111 105,3 \$	PB30244211 96,0 \$	PB30244311 125,7 \$	PB30244411 122,5 \$
4.8 cm	PB48250011 97,6 \$	PB48250111 127,1 \$	PB48244211 127,5 \$	PB48244311 155,8 \$	PB48244411 151,5 \$

Ebat Size	Inox Ayna MIRROR	Inox Parlak Shine	Altın Ayna Gold	Bakır Ayna Bronze	Antrasit Ayna Anthracite
1 cm	PB10244001 62,2 \$	PB10250031 55,5 \$	PB10244201 70,0 \$	PB10244301 95,2 \$	PB10244401 93,1 \$
1.5 cm	PB15244001 67,2 \$	PB15250031 59,6 \$	PB15244201 76,1 \$	PB15244301 105,5 \$	PB15244401 103,2 \$
2.3 cm	PB23244001 72,2 \$	PB23250031 64,2 \$	PB23244201 81,7 \$	PB23244301 115,7 \$	PB23244401 113,0 \$
3 cm	PB30244001 83,6 \$	PB30250031 72,3 \$	PB30244201 96,0 \$	PB30244301 125,7 \$	PB30244401 122,5 \$
4.8 cm	PB48244001 111,5 \$	PB48250031 97,6 \$	PB48244201 127,5 \$	PB48244301 155,8 \$	PB48244401 151,5 \$

Profiline Inox - Dekorlu = 250 cm / Inox Parlak = 250 cm / Altın-Altın Ayna = 244 cm / Bakır-Bakır Ayna = 244 cm / Antrasit-Antrasit Ayna = 244 cm

MADE WITH SWAROVSKI® ELEMENTS

Swarovski kristalleri kullanılarak üretilen mekanlarda fark yaratan bir dekoratif bordür tasarımı **Diamond X E**.



Diamond X E serisi ürünler Made with SWAROVSKI® ELEMENTS kristalleri kullanılarak, 304 kalite paslanmaz çelikten üretilmektedir. Ürünün 10 farklı yüzey renk alternatifi (Inox, Inox Ayna, Inox Parlak, Dekorlu, Altın, Altın Ayna, Bakır, Bakır Ayna, Antrasit, Antrasit Ayna) mevcuttur. Renkli olan ürünler paslanmaz yüzeye pvd kaplama teknolojisi ile üretilmiştir. Ürünün 5 farklı yüzey genişlik alternatifi mevcuttur. (10 mm, 15 mm, 23 mm, 30 mm, 48 mm)

Decorative border profiles are manufactured from 1st grade 304 stainless steel. Profiline offered with 10, 15, 23, 30, 48 mm surface width and produced with 10 mm thickness. Lengths are 244 mm, 250 mm, 270 cm. Length are very according to surface alternatives. Profiline has 10 different surface alternatives. Colored surface are titanium coated. Diamond X E MADE WITH SWAROVSKI® ELEMENTS.

Ebat Size	Inox Satinox	Dekorlu Decor	Altın S. Gold	Bakır S. Bronze	Antrasit S. Anthracite
1 cm	KB10250011 23,0 \$	KB10250111 31,0 \$	KB10244211 31,0 \$	KB10244311 31,0 \$	KB10244411 31,0 \$
1.5 cm	KB15250011 24,3 \$	KB15250111 33,7 \$	KB15244211 33,7 \$	KB15244311 35,1 \$	KB15244411 35,1 \$
2 cm	KB20250011 27,0 \$	KB20250111 37,8 \$	KB20244211 37,8 \$	KB20244311 37,8 \$	KB20244411 37,8 \$
2.3 cm	KB23250011 28,3 \$	KB23250111 40,5 \$	KB23244211 40,5 \$	KB23244311 40,5 \$	KB23244411 40,5 \$
3 cm	KB30250011 31,0 \$	KB30250111 44,5 \$	KB30244211 44,5 \$	KB30244311 46,0 \$	KB30244411 46,0 \$
4.8 cm	KB48250011 43,2 \$	KB48250111 54,0 \$	KB48244211 54,0 \$	KB48244311 54,0 \$	KB48244411 54,0 \$

Ebat Size	Inox Ayna Mirror	Inox Parlak Shine	Altın Ayna Gold	Bakır Ayna Bronze	Antrasit Ayna Anthracite
1 cm	KB10244001 25,6 \$	KB10250031 23,0 \$	KB10244201 31,0 \$	KB10244301 31,0 \$	KB10244401 31,0 \$
1.5 cm	KB15244001 28,3 \$	KB15250031 24,3 \$	KB15244201 33,7 \$	KB15244301 35,1 \$	KB15244401 35,1 \$
2 cm	KB20244001 32,4 \$	KB20250031 27,0 \$	KB20244201 37,8 \$	KB20244301 37,8 \$	KB20244401 37,8 \$
2.3 cm	KB23244001 35,1 \$	KB23250031 28,3 \$	KB23244201 40,5 \$	KB23244301 40,5 \$	KB23244401 40,5 \$
3 cm	KB30244001 37,8 \$	KB30250031 31,0 \$	KB30244201 44,5 \$	KB30244301 46,0 \$	KB30244401 46,0 \$
4.8 cm	KB48244001 51,3 \$	KB48250031 43,2 \$	KB48244201 54,0 \$	KB48244301 54,0 \$	KB48244401 54,0 \$

Profiline Inox - Dekorlu = 250 cm / Inox Parlak = 250 cm / Altın-Altın Ayna = 244 cm / Bakır-Bakır Ayna = 244 cm / Antrasit-Antrasit Ayna = 244 cm

MADE WITH SWAROVSKI® ELEMENTS

0,6 mm kalınlık / 0,6 mm thickness

Mücevher misali çok şık mekanlar
Diamond Tile serisi ürünler ile tasarlandı.



Diamond Tile serisi ürünler Made with SWAROVSKI® ELEMENTS kristalleri kullanılarak, 304 kalite paslanmaz çelikten üretilmektedir. Ürünün 10 farklı yüzey renk alternatifi (Inox, Inox Ayna, Inox Parlak, Dekorlu, Altın, Altın Ayna, Bakır, Bakır Ayna, Antrasit, Antrasit Ayna) mevcuttur. Renkli olan ürünler paslanmaz yüzeye pvd kaplama teknolojisi ile üretilmiştir. Ürünün 3 farklı yüzey genişlik alternatifi mevcuttur. (23 mm, 30 mm, 48 mm)

Decorative border profiles are manufactured from 1st grade 304 stainless steel. Profiline offered with 23, 30, 48 mm surface width and produced with 10 mm thickness. Lengths are 244 mm, 250 mm, 270 cm. Length are very according to surface alternatives. Profiline has 10 different surface alternatives. Colored surface are titanium coated. Diamond Tile MADE WITH SWAROVSKI® ELEMENTS.

Ebat Size	Inox Satinox	Dekorlu Decor	Altın S. Gold	Bakır S. Bronze	Antrasit S. Anthracite
2.3 cm	PB23250012 144,8 \$	PB23250112 152,5 \$	PB23244212 151,5 \$	PB23244312 165,1 \$	PB23244412 162,3 \$
3 cm	PB30250012 146,8 \$	PB30250112 155,6 \$	PB30244212 156,1 \$	PB30244312 172,0 \$	PB30244412 168,7 \$
4.8 cm	PB48250012 215,7 \$	PB48250112 227,1 \$	PB48244212 226,6 \$	PB48244312 248,1 \$	PB48244412 243,7 \$

Ebat Size	Inox Ayna Mirror	Inox Parlak Shine	Altın Gold	Bakır Ayna Bronze	Antrasit Ayna Anthracite
2.3 cm	PB23244002 146,2 \$	PB23250032 140,0 \$	PB23244202 151,5 \$	PB23244302 165,1 \$	PB23244402 162,3 \$
3 cm	PB30244002 150,0 \$	PB30250032 142,0 \$	PB30244202 156,1 \$	PB30244302 172,0 \$	PB30244402 168,7 \$
4.8 cm	PB48244002 218,3 \$	PB48250032 208,5 \$	PB48244202 226,6 \$	PB48244302 248,1 \$	PB48244402 243,7 \$

Profiline Inox - Dekorlu = 250 cm / Inox Parlak = 250 cm / Altın-Altın Ayna = 244 cm / Bakır-Bakır Ayna = 244 cm / Antrasit-Antrasit Ayna = 244 cm

MADE WITH SWAROVSKI® ELEMENTS

Sanatsal banyolar yaratıyor Diamond Form serisi...
Geometrik tasarımlar, SWAROVSKI ELEMENTS
kristallerinin büyüklü ışıltısı çeliğin kimyası değiştiriyor.

Diamond Form serisi ürünler Made with SWAROVSKI® ELEMENTS kristalleri kullanılarak, 304 kalite paslanmaz çelikten üretilmektedir. Ürünün 10 farklı yüzey renk alternatifi (Inox, Inox Ayna, Inox Parlak, Dekorlu, Altın, Altın Ayna, Bakır, Bakır Ayna, Antrasit, Antrasit Ayna) mevcuttur. Renkli olan ürünler paslanmaz yüzeye pvd kaplama teknolojisi ile üretilmiştir. Ürünün 3 farklı yüzey genişlik alternatifi mevcuttur. (30 mm, 48 mm)

Decorative border profiles are manufactured from 1st grade 304 stainless steel. Profiline offered with 30 and 48 mm surface width and produced with 10 mm thickness. Lengths are 244 mm, 250 mm, 270 cm. Length are very according to surface alternatives. Profiline has 10 different surface alternatives. Colored surface are titanium coated. Diamond Form MADE WITH SWAROVSKI® ELEMENTS.



Ebat Size	Kristal Ebat Size	Inox Satinox	Dekorlu Decor	Altın S Gold	Bakır S. Bronze	Antrasit S. Anthracite
3 cm	4x4 cm	PB30250013 127,0 \$	PB30250113 135,7 \$	PB30244213 136,3 \$	PB30244313 152,2 \$	PB30244413 149,0 \$
4.8 cm	4x6 cm	PB48250013 171,8 \$	PB48250113 183,2 \$	PB48244213 184,1 \$	PB48244313 205,6 \$	PB48244413 201,2 \$
3 cm	4x10 cm	PB30250014 137,3 \$	PB30250114 146,1 \$	PB30244214 143,3 \$	PB30244314 159,2 \$	PB30244413 156,0 \$
4.8 cm	6x15 cm	PB48250014 211,1 \$	PB48250114 222,5 \$	PB48244214 215,5 \$	PB48244314 237,0 \$	PB48244413 232,6 \$

Ebat Size	Kristal Ebat Size	Inox Ayna Mirror	Inox Parlak Shine	Altın Ayna Gold	Bakır Ayna Bronze	Antrasit Ayna Anthracite
3 cm	4x4 cm	PB30244003 130,2 \$	PB30250033 117,2 \$	PB30244203 136,3 \$	PB30244303 152,2 \$	PB30244403 149,0 \$
4.8 cm	4x6 cm	PB48244003 175,8 \$	PB48250033 158,5 \$	PB48244203 184,1 \$	PB48244303 205,6 \$	PB48244403 201,2 \$
3 cm	4x10 cm	PB30244004 137,2 \$	PB30250034 124,2 \$	PB30244204 143,3 \$	PB30244304 159,2 \$	PB30244403 156,0 \$
4.8 cm	6x15 cm	PB48244004 207,2 \$	PB48250034 189,8 \$	PB48244204 215,5 \$	PB48244304 237,0 \$	PB48244403 232,6 \$

Profiline Inox - Dekorlu = 250 cm / Inox Parlak = 250 cm / Altın-Altın Ayna = 244 cm / Bakır-Bakır Ayna = 244 cm / Antrasit-Antrasit Ayna = 244 cm

MADE WITH SWAROVSKI® ELEMENTS

Diamond Art serisi
Sanatsal banyolar yaratıyor ...



SWAROVSKI® ELEMENTS
kristallerinin büyüklü ışığı çeliğin kimyası değiştiriyor.



Ebat Size	Kristal Ebat Size	Inox Satinox	Dekorlu Decor	Altın S. Gold	Bakır S. Bronze	Antrasit S. Anthracite					
3 cm	1x1 cm	PB30250015	170,8 \$	PB30250115	179,6 \$	PB30244215	176,2 \$	PB30244315	192,1 \$	PB30244415	188,8 \$
4.8 cm	2.5x2.5 cm	PB48250015	176,1 \$	PB48250115	187,5 \$	PB48244215	188,0 \$	PB48244315	209,5 \$	PB48244415	205,1 \$
4.8 cm	1x1 cm	PB48250016	231,1 \$	PB48250116	242,5 \$	PB48244216	238,0 \$	PB48244316	259,5 \$	PB48244416	255,1 \$
4.8 cm	0=2 cm	PB48250017	217,3 \$	PB48250117	228,7 \$	PB48244217	225,5 \$	PB48244317	247,0 \$	PB48244417	242,6 \$

Ebat Size	Kristal Ebat Size	Inox Ayna Mirror	Inox Parlak Shine	Altın Ayna Gold	Bakır Ayna Bronze	Antrasit Ayna Anthracite					
3 cm	1x1 cm	PB30244005	170,8 \$	PB30250035	157,1 \$	PB30244205	176,2 \$	PB30244305	192,1 \$	PB30244405	188,8 \$
4.8 cm	2.5x2.5 cm	PB48244005	176,1 \$	PB48250035	162,3 \$	PB48244205	188,0 \$	PB48244305	209,5 \$	PB48244405	205,1 \$
4.8 cm	1x1 cm	PB48244006	231,1 \$	PB48250036	212,3 \$	PB48244206	238,0 \$	PB48244306	259,5 \$	PB48244406	255,1 \$
4.8 cm	0=2 cm	PB48244007	217,3 \$	PB48250037	199,8 \$	PB48244207	225,5 \$	PB48244307	247,0 \$	PB48244407	242,6 \$

Profiline Inox - Dekorlu = 250 cm / Inox Parlak = 250 cm / Altın-Altın Ayna = 244 cm / Bakır-Bakır Ayna = 244 cm / Antrasit-Antrasit Ayna = 244 cm

MADE WITH SWAROVSKI® ELEMENTS

Kendinizi özel hissetmenizi sağlayacak detaylar.
Diamond Lux serisi exclusive bir mekan yaratmak isteyenler için tasarlandı.



Diamond LUX serisi ürünler Made with SWAROVSKI[®] ELEMENTS. TS kristalleri kullanılarak, sertifikalı 304 kalite paslanmaz çelikten üretilmektedir. Ürünün 10 farklı yüzey renk alternatifi (Inox, Inox Ayna, Inox Parlak, Dekorlu, Altın, Altın Ayna, Bakır, Bakır Ayna, Antrasit, Antrasit Ayna) mevcuttur. Renkli olan ürünler paslanmaz yüzeye pvd kaplama teknolojisi ile üretilmiştir. Ürünün 5 farklı yüzey genişlik alternatifi mevcuttur.(10 mm, 15 mm, 23 mm, 30 mm, 48 mm)

Decorative border profiles are manufactured from 1st grade 304 stainless steel. Profiline offered with 10, 15, 23, 30, 48 mm surface width and produced with 10 mm thickness. Lengths are 244 mm, 250 mm, 270 cm. Length are very according to surface alternatives. Profiline has 10 different surface alternatives. Colored surface are titanium coated. Diamond Lux MADE WITH SWAROVSKI[®] ELEMENTS.

Ebat Size	Inox Satinox	Inox Ayna Mirror	Altın S. Gold	Bakır S. Bronze	Antrasit S. Anthracite
1 cm	PB10250019 338,2 \$	PB10244219 360,5 \$	PB10244219 360,5 \$	PB10244319 360,5 \$	PB10244419 360,5 \$
1.5 cm	PB15250019 498,6 \$	PB15244219 534,7 \$	PB15244219 534,7 \$	PB15244319 534,7 \$	PB15244419 534,7 \$
2.3 cm	PB23250019 814,8 \$	PB23244219 883,0 \$	PB23244219 883,0 \$	PB23244319 883,0 \$	PB23244419 883,0 \$
3 cm	PB30250019 1.133,0 \$	PB30244219 1.231,2 \$	PB30244219 1.231,2 \$	PB30244319 1.231,2 \$	PB30244419 1.231,2 \$
4.8 cm	PB48250019 1.769,7 \$	PB48244219 1.928,7 \$	PB48244219 1.928,7 \$	PB48244319 1.928,7 \$	PB48244419 1.928,7 \$

Profiline Inox - Dekorlu = 250 cm / Inox Parlak = 250 cm / Altın-Altın Ayna = 244 cm / Bakır-Bakır Ayna = 244 cm / Antrasit-Antrasit Ayna = 244 cm

MADE WITH SWAROVSKI[®] ELEMENTS

ARMONİ



LALEZAR



SARMAŞIK



	Inox Satinox	Dekorlu Decor	Altın S. Gold	Bakır S. Bronze	Antrasit S. Anthracite
Armoni	PB4825001A 362,3 \$	PB4825011A 373,7 \$	PB4824421A 355,5 \$	PB4824431A 377,0 \$	PB4824441A 372,6 \$
Lalezar	PB48250018 362,3 \$	PB48250118 373,7 \$	PB48244218 355,5 \$	PB48244318 377,0 \$	PB48244418 372,6 \$
Sarmaşık	PB4825001S 868,6 \$	PB4825011S 880,0 \$	PB4824421S 813,0 \$	PB4824431S 834,5 \$	PB4824441S 830,1 \$

	Inox Ayna Mirror	Inox Parlak Shine	Altın Ayna Gold	Bakır Ayna Bronze	Antrasit Ayna Anthracite
Armoni	PB4824400A 347,2 \$	PB4825003A 337,3 \$	PB4824420A 355,5 \$	PB4824430A 377,0 \$	PB4824440A 372,6 \$
Lalezar	PB48244008 347,2 \$	PB48250038 337,3 \$	PB48244208 355,5 \$	PB48244308 377,0 \$	PB48244408 372,6 \$
Sarmaşık	PB4824400S 804,7 \$	PB4825003S 806,1 \$	PB4824420S 813,0 \$	PB4824430S 834,5 \$	PB4824440S 830,1 \$

Profiline Inox - Dekorlu = 250 cm / Inox Parlak = 250 cm / Altın-Altın Ayna = 244 cm / Bakır-Bakır Ayna = 244 cm / Antrasit-Antrasit Ayna = 244 cm

MADE WITH SWAROVSKI® ELEMENTS

Profiline Diamond Shine dekoratif görünümüyle mekana şıklık katan paslanmaz çelikten üretilen bitiş profilidir.

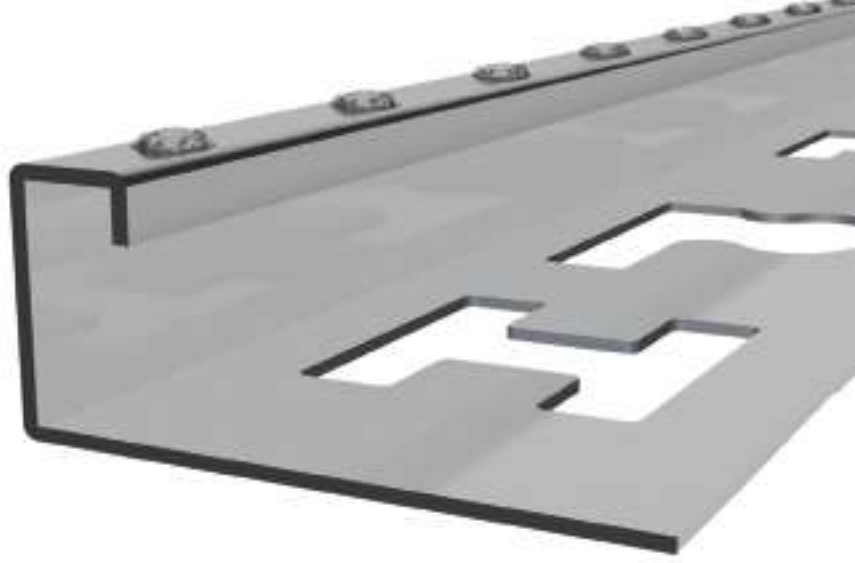

Islak mekanlarınıza değer katan zarif detaylar ... Çeliğin asil dokunuşu ve Swarovski kristallerinin oluşturduğu şıklıkla birleşen Diamond Shine seramik yüzeylerin dış köşelerine ve seramik aralarına dekoratif bordür olarak kullanılabilen özel bir profildir.

Elegant detail for bathroom with Profiline Diamond Shine. Made with SWAROVSKI® ELEMENTS.

Ebat Size	Inox Satinox	Dekorlu Decor	Altın S. Gold	Bakır S. Bronze	Antrasit S. Anthracite
0.8 mm	PBS0825001 200,0 \$	PBS0825011 212,5 \$	PBS0824421 218,7 \$	PBS0824431 237,5 \$	PBS0824441 231,2 \$
10 mm	PBS1025001 200,0 \$	PBS1025011 212,5 \$	PBS1024421 218,7 \$	PBS1024431 237,5 \$	PBS1024441 231,2 \$
12 mm	PBS1225001 200,0 \$	PBS1225011 212,5 \$	PBS1224421 218,7 \$	PBS1224431 237,5 \$	PBS1224441 231,2 \$
14 mm	PBS1425001 200,0 \$	PBS1425011 212,5 \$	PBS1424421 218,7 \$	PBS1424431 237,5 \$	PBS1424441 231,2 \$

Ebat Size	Inox Ayna Mirror	Inox Parlak Shine	Altın Ayna Gold	Bakır Ayna Bronze	Antrasit Ayna Anthracite
0.8 mm	PBS0824400 212,5 \$	PBS0825003 200,0 \$	PBS0824420 218,7 \$	PBS0824430 237,5 \$	PBS0824440 231,2 \$
10 mm	PBS1024400 212,5 \$	PBS1025003 200,0 \$	PBS1024420 218,7 \$	PBS1024430 237,5 \$	PBS1024440 231,2 \$
12 mm	PBS1224400 212,5 \$	PBS1225003 200,0 \$	PBS1224420 218,7 \$	PBS1224430 237,5 \$	PBS1224440 231,2 \$
14 mm	PBS1424400 212,5 \$	PBS1425003 200,0 \$	PBS1424420 218,7 \$	PBS1424430 237,5 \$	PBS1424440 231,2 \$

Profiline Inox - Dekorlu = 250 cm / Inox Parlak = 250 cm / Altın-Altın Ayna = 244 cm / Bakır-Bakır Ayna = 244 cm / Antrasit-Antrasit Ayna = 244 cm

MADE WITH SWAROVSKI® ELEMENTS

ottoman firuze LINEAR



ottoman hanedan LINEAR



ottoman kaside LINEAR



	Ebat Size	Inox Satinox	Inox Ayna Mirror	Inox Parlak Shine	Altın S. Gold	Altın Ayna Gold
Firuze	2.3 cm	PB232500118 100,0 \$	PB232440018 112,5 \$	PB232500318 100,0 \$	PB232442118 125,0 \$	PB232442018 125,0 \$
	3 cm	PB302500118 106,2 \$	PB302440018 118,7 \$	PB302500318 106,2 \$	PB302442118 131,2 \$	PB302442018 131,2 \$
	4.8 cm	PB482500118 112,5 \$	PB482440018 125,0 \$	PB482500318 112,5 \$	PB482442118 137,5 \$	PB482442018 137,5 \$
Hanedan	2.3 cm	PB232500119 100,0 \$	PB232440019 112,5 \$	PB232500319 100,0 \$	PB232442119 125,0 \$	PB232442019 125,0 \$
	3 cm	PB302500119 106,2 \$	PB302440019 118,7 \$	PB302500319 106,2 \$	PB302442119 131,2 \$	PB302442019 131,2 \$
	4.8 cm	PB482500119 112,5 \$	PB482440019 125,0 \$	PB482500319 112,5 \$	PB482442119 137,5 \$	PB482442019 137,5 \$
Kaside	2.3 cm	PB232500120 106,2 \$	PB232440020 118,7 \$	PB232500320 106,2 \$	PB232442120 125,0 \$	PB232442020 125,0 \$
	3 cm	PB302500120 106,2 \$	PB302440020 118,7 \$	PB302500320 106,2 \$	PB302442120 131,2 \$	PB302442020 131,2 \$
	4.8 cm	PB482500120 112,5 \$	PB482440020 125,0 \$	PB482500320 112,5 \$	PB482442120 137,5 \$	PB482442020 137,5 \$
	Ebat Size	Bakır S. Bronze	Bakır Ayna Bronze	Antrasit S. Anthracite	Antrasit Ayna Anthracite	
Firuze	2.3 cm	PB232443118 137,5 \$	PB232443018 137,5 \$	PB232444118 137,5 \$	PB232444018 137,5 \$	
	3 cm	PB302443118 143,7 \$	PB302443018 143,7 \$	PB302444118 143,7 \$	PB302444018 143,7 \$	
	4.8 cm	PB482443118 150,0 \$	PB482443018 150,0 \$	PB482444118 150,0 \$	PB482444018 150,0 \$	
Hanedan	2.3 cm	PB232443119 137,5 \$	PB232443019 137,5 \$	PB232444119 137,5 \$	PB232444019 137,5 \$	
	3 cm	PB302443119 143,7 \$	PB302443019 143,7 \$	PB302444119 143,7 \$	PB302444019 143,7 \$	
	4.8 cm	PB482443119 150,0 \$	PB482443019 150,0 \$	PB482444119 150,0 \$	PB482444019 150,0 \$	
Kaside	2.3 cm	PB232443120 137,5 \$	PB232443020 137,5 \$	PB232444120 137,5 \$	PB232444020 137,5 \$	
	3 cm	PB302443120 143,7 \$	PB302443020 143,7 \$	PB302444120 143,7 \$	PB302444020 143,7 \$	
	4.8 cm	PB482443120 150,0 \$	PB482443020 150,0 \$	PB482444120 150,0 \$	PB482444020 150,0 \$	

Profiline Inox - Dekorlu = 250 cm / Inox Parlak = 250 cm / Altın-Altın Ayna = 244 cm / Bakır-Bakır Ayna = 244 cm / Antrasit-Antrasit Ayna = 244 cm

MADE WITH SWAROVSKI® ELEMENTS

Ottoman DIAMOND serisi ürünler Made with SWAROVSKI® ELEMENTS. TS kristalleri kullanılarak sertifikalı 304 kalite paslanmaz çelikten üretilmektedir. Ürünün 10 farklı yüzey renk alternatifi (Inox, Inox Ayna, Inox Parlak, Dekorlu, Altın, Altın Ayna, Bakır, Bakır Ayna, Antrasit, Antrasit Ayna) mevcuttur. Renkli olan ürünler paslanmaz yüzeye pvd kaplama teknolojisi ile üretilmiştir. Ürünün 48 mm yüzey genişlik alternatifi mevcuttur.

ottoman firuze DIAMOND

ottoman hanedan DIAMOND

ottoman kaside DIAMOND

Decorative border profiles are manufactured from 1st grade 304 stainless steel. Profiline offered with 48 mm surface width and produced with 10 mm thickness. Lengths are 244 mm, 250 mm, 270 cm. Length are very according to surface alternatives. Profiline has 10 different surface alternatives. Colored surface are titanium coated. Ottoman DIAMOND Made with SWAROVSKI® ELEMENTS.

	Ebat Size	Inox Satinox	Inox Ayna Mirror	Inox Parlak Decor	Altın S. Gold	Altın Ayna Gold
Firuze	2.3 cm	PB232500115 125,0 \$	PB232440015 137,5 \$	PB232500315 125,0 \$	PB232442115 150,0 \$	PB232442015 150,0 \$
	3 cm	PB302500115 137,5 \$	PB302440015 150,0 \$	PB302500315 137,5 \$	PB302442115 162,5 \$	PB302442015 162,5 \$
	4.8 cm	PB482500115 150,0 \$	PB482440015 162,5 \$	PB482500315 150,0 \$	PB482442115 175,0 \$	PB482442015 175,0 \$
Hanedan	2.3 cm	PB232500113 125,0 \$	PB232440013 137,5 \$	PB232500313 125,0 \$	PB232442113 150,0 \$	PB232442013 150,0 \$
	3 cm	PB302500113 137,5 \$	PB302440013 150,0 \$	PB302500313 137,5 \$	PB302442113 162,5 \$	PB302442013 162,5 \$
	4.8 cm	PB482500113 150,0 \$	PB482440013 162,5 \$	PB482500313 150,0 \$	PB482442113 175,0 \$	PB482442013 175,0 \$
Kaside	2.3 cm	PB232500114 125,0 \$	PB232440014 137,5 \$	PB232500314 125,0 \$	PB232442114 150,0 \$	PB232442014 150,0 \$
	3 cm	PB302500114 137,5 \$	PB302440014 150,0 \$	PB302500314 137,5 \$	PB302442114 162,5 \$	PB302442014 162,5 \$
	4.8 cm	PB482500114 150,0 \$	PB482440014 162,5 \$	PB482500314 150,0 \$	PB482442114 175,0 \$	PB482442014 175,0 \$
	Ebat Size	Bakır S. Bronze	Bakır Ayna Bronze	Antrasit S. Anthracite	Antrasit Ayna Anthracite	
Firuze	2.3 cm	PB232443115 162,5 \$	PB232443015 162,5 \$	PB232444115 162,5 \$	PB232444015 162,5 \$	
	3 cm	PB302443115 175,0 \$	PB302443015 175,0 \$	PB302444115 175,0 \$	PB302444015 175,0 \$	
	4.8 cm	PB482443115 187,5 \$	PB482443015 187,5 \$	PB482444115 187,5 \$	PB482444015 187,5 \$	
Hanedan	2.3 cm	PB232443113 162,5 \$	PB232443013 162,5 \$	PB232444113 162,5 \$	PB232444013 162,5 \$	
	3 cm	PB302443113 175,0 \$	PB302443013 175,0 \$	PB302444113 175,0 \$	PB302444013 175,0 \$	
	4.8 cm	PB482443113 187,5 \$	PB482443013 187,5 \$	PB482444113 187,5 \$	PB482444013 187,5 \$	
Kaside	2.3 cm	PB232443114 162,5 \$	PB232443014 162,5 \$	PB232444114 162,5 \$	PB232444014 162,5 \$	
	3 cm	PB302443114 175,0 \$	PB302443014 175,0 \$	PB302444114 175,0 \$	PB302444014 175,0 \$	
	4.8 cm	PB482443114 187,5 \$	PB482443014 187,5 \$	PB482444114 187,5 \$	PB482444014 187,5 \$	

Profiline Inox - Dekorlu = 250 cm / Inox Parlak = 250 cm / Altın-Altın Ayna = 244 cm / Bakır-Bakır Ayna = 244 cm / Antrasit-Antrasit Ayna = 244 cm

MADE WITH SWAROVSKI® ELEMENTS

ottoman abide DIAMOND



ottoman şahmaran DIAMOND



	Ebat Size	Inox Satinox	Inox Ayna Mirror	Inox Parlak Decor	Altın S. Gold	Altın Ayna Gold					
Abide	2.3 cm	PB232500116	125,0 \$	PB232440016	137,5 \$	PB232500316	125,0 \$	PB232442116	150,0 \$	PB232442016	150,0 \$
	3 cm	PB302500116	137,5 \$	PB302440016	150,0 \$	PB302500316	137,5 \$	PB302442116	162,5 \$	PB302442016	162,5 \$
	4.8 cm	PB482500116	150,0 \$	PB482440016	162,5 \$	PB482500316	150,0 \$	PB482442116	175,0 \$	PB482442016	175,0 \$
Şahmaran	2.3 cm	PB232500117	125,0 \$	PB232440017	137,5 \$	PB232500317	125,0 \$	PB232442117	150,0 \$	PB232442017	150,0 \$
	3 cm	PB302500117	137,5 \$	PB302440017	150,0 \$	PB302500317	137,5 \$	PB302442117	162,5 \$	PB302442017	162,5 \$
	4.8 cm	PB482500117	150,0 \$	PB482440017	162,5 \$	PB482500317	150,0 \$	PB482442117	175,0 \$	PB482442017	175,0 \$

	Ebat Size	Bakır S. Bronze	Bakır Ayna Bronze	Antrasit S. Anthracite	Antrasit Ayna Anthracite				
Abide	2.3 cm	PB232443116	162,5 \$	PB232443016	162,5 \$	PB232444116	162,5 \$	PB232444016	162,5 \$
	3 cm	PB302443116	175,0 \$	PB302443016	175,0 \$	PB302444116	175,0 \$	PB302444016	175,0 \$
	4.8 cm	PB482443116	187,5 \$	PB482443016	187,5 \$	PB482444116	187,5 \$	PB482444016	187,5 \$
Şahmaran	2.3 cm	PB232443117	162,5 \$	PB232443017	162,5 \$	PB232444117	162,5 \$	PB232444017	162,5 \$
	3 cm	PB302443117	175,0 \$	PB302443017	175,0 \$	PB302444117	175,0 \$	PB302444017	175,0 \$
	4.8 cm	PB482443117	187,5 \$	PB482443017	187,5 \$	PB482444117	187,5 \$	PB482444017	187,5 \$

Profiline Inox - Dekorlu = 250 cm / Inox Parlak = 250 cm / Altın-Altın Ayna = 244 cm / Bakır-Bakır Ayna = 244 cm / Antrasit-Antrasit Ayna = 244 cm

MADE WITH SWAROVSKI® ELEMENTS

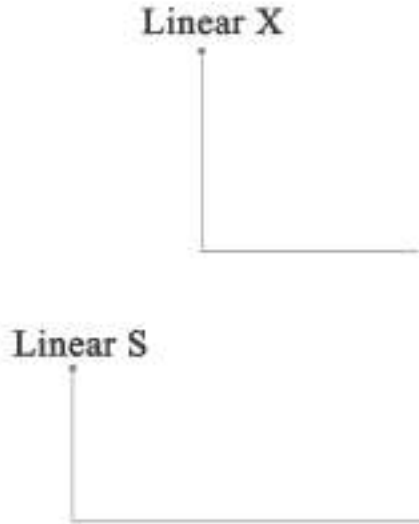

Linear X

EBAT size	Inox Satinox	Dekorlu Decor	Altın S Gold	Bakır S Bronze	Antrasit S Anthracite					
2 cm	PB200600140	6,2 \$	PB200601140	9,0 \$	PB200602140	12,6 \$	PB200603140	18,0 \$	PB200604140	16,9 \$

EBAT size	Inox Ayna Mirror	Inox Parlak Shine	Altın Ayna Gold	Bakır Ayna Bronze	Antrasit Ayna Anthracite					
2 cm	PB200600040	10,5 \$	PB200600340	6,2 \$	PB200602040	12,6 \$	PB200603040	18,0 \$	PB200604040	16,9 \$

Linear S

EBAT size	Inox Satinox	Dekorlu Decor	Altın S Gold	Bakır S Bronze	Antrasit S Anthracite					
6 x 60 cm	PB600600141	10,8 \$	PB600601141	12,7 \$	PB600602141	20,5 \$	PB600603141	27,6 \$	PB600604141	24,7 \$
6 x 90 cm	PB600900141	21,7 \$	PB600901141	25,4 \$	PB600902141	41,7 \$	PB600903141	55,2 \$	PB600904141	49,5 \$
6 x 120 cm	PB601200141	27,1 \$	PB601201141	31,7 \$	PB601202141	50,0 \$	PB601203141	69,0 \$	PB601204141	61,9 \$

EBAT size	Inox Ayna Mirror	Inox Parlak Shine	Altın Ayna Gold	Bakır Ayna Bronze	Antrasit Ayna Anthracite					
6 x 60 cm	PB600600041	16,8 \$	PB600600341	10,8 \$	PB600602041	20,5 \$	PB600603041	27,6 \$	PB600604041	24,7 \$
6 x 90 cm	PB600900041	33,6 \$	PB600900341	21,7 \$	PB600902041	41,7 \$	PB600903041	55,2 \$	PB600904041	49,5 \$
6 x 120 cm	PB601200041	16,8 \$	PB601200341	27,1 \$	PB601202041	50,0 \$	PB601203041	69,0 \$	PB601204041	61,9 \$

Profiline Inox - Dekorlu = 250 cm / Inox Parlak = 250 cm / Altın-Altın Ayna = 244 cm / Bakır-Bakır Ayna = 244 cm / Antrasit-Antrasit Ayna = 244 cm

MADE WITH SWAROVSKI® ELEMENTS



Profiline 3D STAR

PROFILINE 3D



3d STAR W

EBAT size	Inox Satinox	Inox Ayna Mirror	Altın Ayna Gold	Bakır Ayna Bronze
7 cm	PB702500128 120,0 \$	PB702440028 171,2 \$	PB702442028 200,0 \$	PB702443028 241,2 \$



3d STAR

EBAT size	Inox Satinox	Inox Ayna Mirror	Altın Ayna Gold	Bakır Ayna Bronze
4.5 cm	PB452500127 72,5 \$	PB452440027 106,2 \$	PB452442027 125,0 \$	PB452443027 156,2 \$



3d ANGLE

EBAT size	Inox Satinox	Inox Ayna Mirror	Altın Ayna Gold	Bakır Ayna Bronze
6.5 cm	PB652500126 72,5 \$	PB652440026 106,2 \$	PB652442006 125,0 \$	PB652443026 156,2 \$



Profiline Inox - Dekorlu = 250 cm / Inox Parlak = 250 cm / Altın-Altın Ayna = 244 cm / Bakır-Bakır Ayna = 244 cm / Antrasit-Antrasit Ayna = 244 cm

MADE WITH SWAROVSKI® ELEMENTS

Ebat size	Inox Ayna mirror	Altın Ayna gold	Bakır Ayna bronze	Antrasit Ayna anthracite
8 cm	PB8024400VG 170 \$	PB8024420VG 185 \$	PB8024430VG 195 \$	PB8024440VG 205 \$

VEGA



Ebat size	Inox Ayna mirror	Altın Ayna gold	Bakır Ayna bronze	Antrasit Ayna anthracite
6 cm	PB6024400CP 175 \$	PB6024420CP 190 \$	PB6024430CP 200 \$	PB6024440CP 210 \$

CAPELLA



Profiline Inox - Dekorlu = 250 cm / Inox Parlak = 250 cm / Altın-Altın Ayna = 244 cm / Bakır-Bakır Ayna = 244 cm / Antrasit-Antrasit Ayna = 244 cm

MADE WITH SWAROVSKI® ELEMENTS

PROFILINE 3D

P Dizayn

BELLATRIX



EBAT size	Inox Ayna mirror	Altın Ayna gold	Bakır Ayna bronze	Antrasit Ayna anthracite
8 cm	PB8024400BX 205 \$	PB8024420BX 225 \$	PB8024430BX 230 \$	PB8024440BX 240 \$

VENÜS



EBAT size	Inox Ayna mirror	Altın Ayna gold	Bakır Ayna bronze	Antrasit Ayna anthracite
8 cm	PB8024400VS 170 \$	PB8024420VS 185 \$	PB8024430VS 195 \$	PB8024440VS 205 \$

BUTTERFLY



EBAT size	Inox Ayna mirror	Altın Ayna gold	Bakır Ayna bronze	Antrasit Ayna anthracite
8 cm	PB8024400BY 170 \$	PB8024420B 185 \$	PB8024430BY 195 \$	PB8024440BY 205 \$

MADE WITH SWAROVSKI® ELEMENTS

Ebat size	Inox Ayna mirror	Altın Ayna gold	Bakır Ayna bronze	Antrasit Ayna anthracite
8 cm	PB8024400DN 205 \$	PB8024420DN 225 \$	PB8024430DN 230 \$	PB8024440DN 240 \$

DOLPHIN



Ebat size	Inox Ayna mirror	Altın Ayna gold	Bakır Ayna bronze	Antrasit Ayna anthracite
8 cm	PB8024400FR 170 \$	PB8024420FR 185 \$	PB8024430FR 195 \$	PB8024440FR 205 \$

FLOWER



Profiline Inox - Dekorlu = 250 cm / Inox Parlak = 250 cm / Altın-Altın Ayna = 244 cm / Bakır-Bakır Ayna = 244 cm / Antrasit-Antrasit Ayna = 244 cm

MADE WITH SWAROVSKI® ELEMENTS

PROFILINE 3D



Infinity S

Ebat size	Inox Ayna mirror	Altın Ayna gold	Bakır Ayna bronze	Antrasit Ayna anthracite
8 cm	PB8024400IS 205 \$	PB8024420IS 225 \$	PB8024420IS 230 \$	PB8024440IS 240 \$



Infinity R

Ebat size	Inox Ayna mirror	Altın Ayna gold	Bakır Ayna bronze	Antrasit Ayna anthracite
8 cm	PB8024400IR 205 \$	PB8024420IR 225 \$	PB8024430IR 230 \$	PB8024440IR 240 \$



Infinity B

Ebat size	Inox Ayna mirror	Altın Ayna gold	Bakır Ayna bronze	Antrasit Ayna anthracite
8 cm	PB8024400IB 205 \$	PB8024420IB 225 \$	PB8024430IB 230 \$	PB8024440IB 240 \$



Profiline Inox - Dekorlu = 250 cm / Inox Parlak = 250 cm / Altın-Altın Ayna = 244 cm / Bakır-Bakır Ayna = 244 cm / Antrasit-Antrasit Ayna = 244 cm

MADE WITH SWAROVSKI® ELEMENTS

Ebat size	Inox Ayna mirror	Altın Ayna gold	Bakır Ayna bronze	Antrasit Ayna anthracite				
8 cm	PB80244001D	205 \$	PB80244201D	225 \$	PB80244301D	230 \$	PB80244401D	240 \$

Infinity D



Ebat size	Inox Ayna mirror	Altın Ayna gold	Bakır Ayna bronze	Antrasit Ayna anthracite				
8 cm	PB80244001F	205 \$	PB80244201F	225 \$	PB80244301F	230 \$	PB80244401F	240 \$

Infinity F



Profiline Inox - Dekorlu = 250 cm / Inox Parlak = 250 cm / Altın-Altın Ayna = 244 cm / Bakır-Bakır Ayna = 244 cm / Antrasit-Antrasit Ayna = 244 cm

MADE WITH SWAROVSKI® ELEMENTS

PROFILINE 3D

P Dizayn

Ebat size	Inox- Inox Dekorlu Satinox - Decor	
4 cm	PB40250011K	50 \$

Kasablanka - S



Ebat size	Kristal Ebat size	Inox- Inox Dekorlu Satinox - Decor	
4 cm	1 cm x 1 cm Beyaz	PB40250011KS	150 \$

Kasablanka - S DIAMOND



Ebat size	Inox- Inox Dekorlu Satinox - Decor	
8,5 cm	PB85250011K	120 \$

Kasablanka - 3S



Profiline Inox - Dekorlu = 250 cm / Inox Parlak = 250 cm / Altın-Altın Ayna = 244 cm / Bakır-Bakır Ayna = 244 cm / Antrasit-Antrasit Ayna = 244 cm

MADE WITH SWAROVSKI® ELEMENTS

Ebat **Inox- Inox Dekorlu**
size Satinox - Decor
6 cm PB60250011K 85 \$

Kasablanka - 2S



Ebat **Inox- Inox Dekorlu**
size Satinox - Decor
6 cm PB60250011KS 185 \$

Kasablanka - 2S DIAMOND



Ebat **Inox- Inox Dekorlu**
size Satinox - Decor
8,5 cm PB85250011KS 220 \$

Kasablanka - 3S DIAMOND



Profiline Inox - Dekorlu = 250 cm / Inox Parlak = 250 cm / Altın-Altın Ayna = 244 cm / Bakır-Bakır Ayna = 244 cm / Antrasit-Antrasit Ayna = 244 cm

MADE WITH SWAROVSKI® ELEMENTS

PROFILINE 3D



Ebat size	Inox- Inox Dekorlu Satinox - Decor	Altın S Gold
4 cm	PB40250011L	70 \$ PB40244212L 105 \$

Lilyum S

Lilyum - S DIAMOND

Ebat size	Inox- Inox Dekorlu Satinox - Decor	Altın S Gold
4 cm	PB40250011LS	170 \$ PB40244212LS 205 \$

Lilyum - 3S

Ebat size	Inox- Inox Dekorlu Satinox - Decor	Altın S Gold
8 cm	PB80250011L3S	105 \$ PB80244212L3S 190 \$

Lilyum - 3S DIAMOND

Ebat size	Inox- Inox Dekorlu Satinox - Decor	Altın S Gold
8 cm	PB80250011LSD	205 \$ PB80244212LSD 290 \$



Profiline Inox - Dekorlu = 270 cm / Inox Parlak = 250 cm / Altın-Altın Ayna = 244 cm / Bakır-Bakır Ayna = 244 cm / Antrasit-Antrasit Ayna = 244 cm

MADE WITH SWAROVSKI® ELEMENTS

Ebat size	Inox- Inox Dekorlu Satinox - Decor	
7 cm	PB70250101K	95 \$

Kardelen

Kardelen Diamond

Ebat size	Kristal Ebat size	Inox- Inox Dekorlu Satinox - Decor	
7 cm	1 cm x 1 cm Sahara Yeşil	PB70250101KS	195 \$

Krizantem

Ebat size	Inox Satinox	
7 cm	PB70250001K	75 \$

Krizantem Diamond

Ebat size	Kristal Ebat size	Inox Satinox	
7 cm	2,5 cm x 2,5 cm Beyaz	PB70250001KS	175 \$

Profiline Inox - Dekorlu = 270 cm / Inox Parlak = 250 cm / Altın-Altın Ayna = 244 cm / Bakır-Bakır Ayna = 244 cm / Antrasit-Antrasit Ayna = 244 cm

MADE WITH SWAROVSKI® ELEMENTS

PROFILINE 3D

P Dizayn

Ebat size	Inox Satinox
9 cm	PB90250001M 110 \$

Mimoza



Ebat size	Kristal Ebat size	Inox Satinox
9 cm	1 cm x 1 cm Sahara Yeşil	PB90250001MS 210 \$

Mimoza Diamond



Ebat size	Inox - Dekorlu Satinox - Decor
8,5 cm	PB8525001A 130 \$

Açelya



Açelya Diamond

Ebat size	Kristal Ebat size	Inox - Dekorlu Satinox - Decor	Altın S Gold
8,5 cm	1 cm x 1 cm	PB85250011AS 230 \$	PB85244212AS 190 \$



Profiline Inox - Dekorlu = 270 cm / Inox Parlak = 250 cm / Altın-Altın Ayna = 244 cm / Bakır-Bakır Ayna = 244 cm / Antrasit-Antrasit Ayna = 244 cm

MADE WITH SWAROVSKI® ELEMENTS

Ebat size	Inox Ayna mirror	Altın Ayna gold	Bakır Ayna bronze	Antrasit Ayna anthracite
4,5 cm	PB4524400DN 68 \$	PB4524420DN 82 \$	PB4524430DN 111 \$	PB4524440DN 99 \$

Dragon

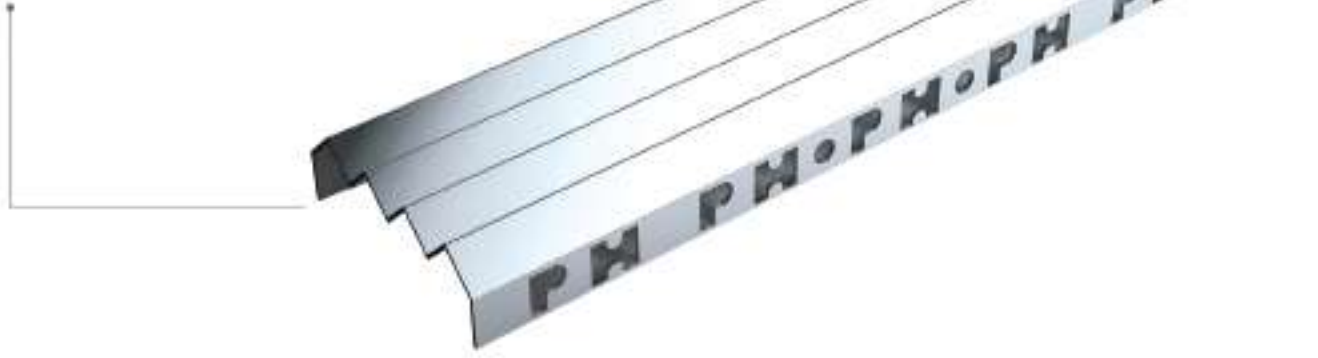

Profiline Inox - Dekorlu = 270 cm / Inox Parlak = 250 cm / Altın-Altın Ayna = 244 cm / Bakır-Bakır Ayna = 244 cm / Antrasit-Antrasit Ayna = 244 cm

MADE WITH SWAROVSKI® ELEMENTS

INOXYLINE

Paslanmaz Çelik Mozaik

Metalin ağırbaşlı güzelliğini miras alan paslanmaz çelik mozaiklerimiz ile 'Swarovski Elements' kristallerinin büyüleyici ışılmasını birleştiriyoruz.

Stainless Steel Mosaic

DECORATIVE BORDER PROFILES are manufactured from 1st grade 304 stainless steel, has 10 different surface alternatives. Profile offered with 10,15,23,30,48 mm surface width and produced with 10 mm thickness. Lengths are 244 cm, 250 cm, 270 cm. Length are very according to surfaces alternatives.



3d - STAR

Yaprak: 27,7 cm x 27,2 cm - 13,2 yaprak / m²
Bordür: 2,2 cm x 27,2 cm - 3,7 bordür / m
Mosaic Size 2,5 cm x 2,5 cm x 2,5 cm

3d - STAR

	Inox /satinox	Dekorlu /decor	Inox Ayna /mirror	Altın Ayna /gold	Bakır Ayna /bronze	Inox Dekorlu /inox decor
Yaprak	IY1300 73,75 \$	IY1311 88,50 \$	IY1355 98,75 \$	IY1366 133,00 \$	IY1377 133,00 \$	IY1301 88,50 \$
Bordür	IB1300 6,13 \$	IB1311 7,38 \$	IB1355 8,25 \$	IB1366 11,13 \$	IB1377 11,13 \$	IB1301 7,38 \$



3d - ANGLE

Yaprak: 28,8 cm x 28,8 cm - 12 yaprak / m²
Bordür: 4 cm x 28,8 cm - 3,4 bordür / m
Mosaic Size 4 cm x 4 cm

3d - ANGLE

	Inox /satinox	Dekorlu /decor	Inox Ayna /mirror	Altın Ayna /gold	Bakır Ayna /bronze	Inox Dekorlu /inox decor
Yaprak	IY1600 41,25 \$	IY1611 49,50 \$	IY1655 56,88 \$	IY1666 74,25 \$	IY1677 74,25 \$	IY1601 49,50 \$
Bordür	IB1600 5,88 \$	IB1611 7,13 \$	IB1655 8,13 \$	IB1666 10,63 \$	IB1677 10,63 \$	IB1601 7,13 \$

3D Star ve Angle serisi mozaikler, 304 kalite paslanmaz çelikten üretilmektedir. Ürünün 5 farklı yüzey renk alternatifi (Inox, Dekorlu, Inox Ayna, Altın Ayna, Bakır Ayna) mevcuttur. Renkli olan ürünler paslanmaz yüzeye pvd kaplama teknolojisi ile üretilmiştir.

Mosaic produced 304 quality stainless with 31 series and 10 different surface options, thickness is 7,5 mm. It using as a decorative wall covering. Gives decorative and a stylish look to your bathroom with the use in ceramics.



KASABLANKA

Yaprak: 27,4 cm x 27,4 cm - 13,2 yaprak / m²
Bordür: 2,1 cm x 27,4 cm - 3,7 bordür / m
Mosaic Size 2,1 cm x 2,1 cm - 2,1 cm x 6,7 cm

Kasablanka

	Inox /satinox	Dekorlu /decor	Altın /gold	Bakır /bronz	Antrasit /anthracite	Inox Dekorlu /inox decor	Dekorlu Inox /decor inox
Yaprak	IY2700 26,25 \$	IY2711 31,25 \$	IY2722 48,25 \$	IY2733 48,25 \$	IY2744 48,25 \$	IY2701 31,25 \$	IY2710 31,25 \$
Bordür	IB2700 2,19 \$	IB2711 2,63 \$	IB2722 4,00 \$	IB2733 4,00 \$	IB2744 4,00 \$	IB2701 2,63 \$	IB2710 2,63 \$



STARLIÇE

Yaprak: 27,4 cm x 27,4 cm - 13,2 yaprak / m²
Bordür: 2,1 cm x 27,4 cm - 3,7 bordür / m
Mosaic Size 2,1 cm x 2,1 cm - 2,1 cm x 6,7 cm

Starlıçe

	Inox /satinox	Dekorlu /decor	Altın /gold	Bakır /bronz	Antrasit /anthracite	Inox Dekorlu /inox decor	Dekorlu Inox /decor inox
Yaprak	IY4800 26,88 \$	IY4811 32,25 \$	IY4822 48,25 \$	IY4833 48,25 \$	IY4844 48,25 \$	IY4801 32,25 \$	IY4810 32,25 \$
Bordür	IB4800 9,00 \$	IB4811 10,75 \$	IB4822 16,06 \$	IB4833 16,06 \$	IB4844 16,06 \$	IB4801 10,75 \$	IB4810 10,75 \$

Kazablanka ve Starlıçe serisi mozaikler, 304 kalite paslanmaz çelikten üretilmektedir. Ürünün 5 farklı yüzey renk alternatifi (Inox, Dekorlu, Inox Ayna, Altın Ayna, Bakır Ayna) mevcuttur. Renkli olan ürünler paslanmaz yüzeye pvd kaplama teknolojisi ile üretilmiştir.

Mosaic produced 304 quality stainless with 31 series and 10 different surface options, thickness is 7,5 mm. It using as a decorative wall covering. Gives decorative and a stylish look to your bathroom with the use in ceramics.



MİMOZA

Yaprak: 27,4 cm x 27,4 cm - 13,2 yaprak / m²
 Dikey Bordür: 27,4 cm x 6,7 cm - 3,7 bordür / m
 Yatay Bordür: 2,1 cm x 27,4 cm - 3,7 bordür / m
 Mosaic Size 2,1 cm x 6,7 cm

Mimoza

	Inox /satinox	Dekorlu /decor	Altın /gold	Bakır /bronz	Antrasit /anthracite	Inox Dekorlu /inox decor
Yaprak	IY3300	IY3311	IY3322	IY3333	IY3344	IY3301
D.Bordür	IB3300	IB3311	IB3322	IB3333	IB3344	IB3301
Y.Bordür	IB3400	IB3411	IB3422	IB3433	IB3444	IB3401
	25,63 \$	30,63 \$	46,25 \$	46,25 \$	46,25 \$	30,63 \$
	6,38 \$	7,75 \$	11,56 \$	11,56 \$	11,56 \$	7,75 \$
	2,13 \$	2,63 \$	3,88 \$	3,88 \$	3,88 \$	2,63 \$



FREZYA

Yaprak: 29,8 cm x 29,8 cm - 11,2 yaprak / m²
 Bordür: 4,8 cm x 29,8 cm - 3,4 bordür / m
 Mosaic Size 4,8 cm x 4,8 cm

Frezya

	Inox /satinox	Dekorlu /decor	Altın /gold	Bakır /bronz	Antrasit /anthracite	Inox Dekorlu /inox decor
Yaprak	IY1200	IY1211	IY1222	IY1233	IY1244	IY1201
Bordür	IB1200	IB1211	IB1222	IB1233	IB1244	IB1201
	21,25 \$	25,63 \$	38,25 \$	38,25 \$	38,25 \$	25,63 \$
	3,54 \$	4,28 \$	6,38 \$	6,38 \$	6,38 \$	4,28 \$

Mimoza ve Frezya serisi mozaikler, 304 kalite paslanmaz çelikten üretilmektedir. Ürünün 5 farklı yüzey renk alternatifi (Inox, Dekorlu, Inox Ayna, Altın Ayna, Bakır Ayna) mevcuttur. Renkli olan ürünler paslanmaz yüzeye pvd kaplama teknolojisi ile üretilmiştir.

Mosaic produced 304 quality stainless with 31 series and 10 different surface options, thickness is 7,5 mm. It using as a decorative wall covering. Gives decorative and a stylish look to your bathroom with the use in ceramics.



LİLYUM

Yaprak: 27,4 cm x 27,4 cm - 13,2 yaprak / m²
Bordür: 2,1 cm x 27,4 cm - 3,7 bordür / m
Mosaic Size 2,1 cm x 2,1 cm

Lilyum

	Inox /satinox	Dekorlu /decor	Altın /gold	Bakır /bronz	Antrasit /anthracite	Inox Dekorlu /inox decor
Yaprak	IY3900 30,00 \$	IY3911 35,63 \$	IY3922 54,00 \$	IY3933 54,00 \$	IY3944 54,00 \$	IY3901 35,63 \$
Bordür	IB3900 2,50 \$	IB3911 3,00 \$	IB3922 4,50 \$	IB3933 4,50 \$	IB3944 4,50 \$	IB3901 3,00 \$



KAMELYA

Yaprak: 27,4 cm x 27,4 cm - 13,2 yaprak / m²
Bordür: 2,1 cm x 27,4 cm - 3,7 bordür / m
Mosaic Size 2,1 cm x 6,7 cm

Kamelya

	Inox /satinox	Dekorlu /decor	Altın /gold	Bakır /bronz	Antrasit /anthracite	Inox Dekorlu /inox decor
Yaprak	IY3000 25,63 \$	IY3011 30,63 \$	IY3022 46,25 \$	IY3033 46,25 \$	IY3044 46,25 \$	IY3001 30,63 \$
Bordür	IB3000 2,13 \$	IB3011 2,63 \$	IB3022 3,88 \$	IB3033 3,88 \$	IB3044 3,88 \$	IB3001 2,63 \$

Lilyum ve Kamelya serisi mozaikler, 304 kalite paslanmaz çelikten üretilmektedir. Ürünün 5 farklı yüzey renk alternatifi (Inox, Dekorlu, Inox Ayna, Altın Ayna, Bakır Ayna) mevcuttur. Renkli olan ürünler paslanmaz yüzeye pvd kaplama teknolojisi ile üretilmiştir.

Mosaic produced 304 quality stainless with 31 series and 10 different surface options, thickness is 7,5 mm. It using as a decorative wall covering. Gives decorative and a stylish look to your bathroom with the use in ceramics.

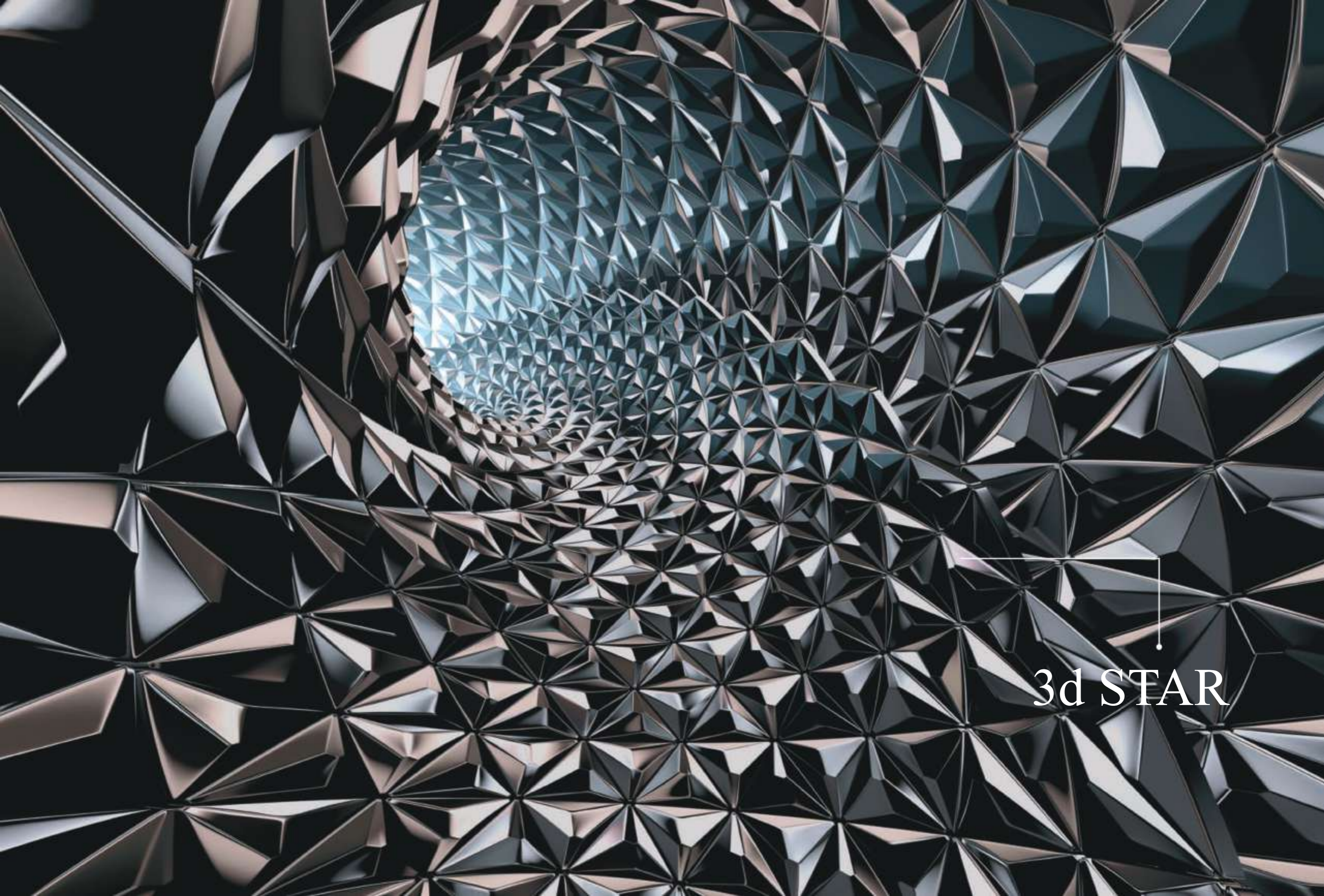

3d STAR

INOXYLINE 3D



NİLÜFER

Yaprak: 29,8 cm x 30,2 cm - 11,2 yaprak / m²
Dikey Bordür: 29,8 cm x 15 cm - 3,4 bordür / m
Yatay Bordür: 4,8 cm x 30,2 cm - 3,4 bordür / m
Mosaic Size 4,8 cm x 10 cm

Nilüfer

	Inox /satinox	Dekorlu /decor	Altın /gold	Bakır /bronz	Antrasit /anthracite	Inox Dekorlu /inox decor	Dekorlu Inox /decor inox
Yaprak	IY7200 21,25 \$	IY7211 25,63 \$	IY7222 39,75 \$	IY7233 39,75 \$	IY7244 39,75 \$	IY7201 25,63 \$	IY7210 25,63 \$
D.Bordür	IB7200 10,63 \$	IB7211 12,88 \$	IB7222 19,88 \$	IB7233 19,88 \$	IB7244 19,88 \$	IB7201 12,88 \$	IB7210 12,88 \$
Y.Bordür	IB7300 3,54 \$	IB7311 4,28 \$	IB7322 6,63 \$	IB7333 6,63 \$	IB7344 6,63 \$	IB7301 4,28 \$	IB7310 4,28 \$



KRİZANTEM

Yaprak: 29,8 cm x 30,4 cm - 11,2 yaprak / m²
Bordür: 4,8 cm x 30,4 cm - 3,4 bordür / m
Mosaic Size 4,8 cm x 10 cm

Krizantem

	Inox /satinox	Dekorlu /decor	Altın /gold	Bakır /bronz	Antrasit /anthracite	Inox Dekorlu /inox decor
Yaprak	IY4500 22,50 \$	IY4511 26,88 \$	IY4522 40,50 \$	IY4533 40,50 \$	IY4544 40,50 \$	IY4501 26,8 \$
Bordür	IB4500 3,50 \$	IB4511 4,25 \$	IB4522 6,75 \$	IB4533 6,75 \$	IB4544 6,75 \$	IB4501 4,25 \$

Nilüfer ve Krizantem serisi mozaikler, 304 kalite paslanmaz çelikten üretilmektedir. Ürünün 5 farklı yüzey renk alternatifini (Inox, Dekorlu, Inox Ayna, Altın Ayna, Bakır Ayna) mevcuttur. Renkli olan ürünler paslanmaz yüzeye pvd kaplama teknolojisi ile üretilmiştir.

Mosaic produced 304 quality stainless with 31 series and 10 different surface options, thickness is 7,5 mm. It using as a decorative wall covering. Gives decorative and a stylish look to your bathroom with the use in ceramics.



SİNADA

Yaprak: 27 cm x 27 cm - 13,5 yaprak / m²
Bordür: 1,5 cm x 27 cm - 3,7 bordür / m
Mosaic Size 1,5 cm x 1,5 cm

Sinada

	Inox /satinox	Dekorlu /decor	Altın /gold	Bakır /bronz	Antrasit /anthracite	Inox Dekorlu /inox decor
Yaprak	IY4200 41,25 \$	IY4211 49,38 \$	IY4222 73,63 \$	IY4233 73,63 \$	IY4244 73,63 \$	IY4201 49,38 \$
Bordür	IB4200 2,50 \$	IB4211 3,00 \$	IB4222 4,63 \$	IB4233 4,63 \$	IB4244 4,63 \$	IB4201 3,00 \$



MANOLYA

Yaprak: 27 cm x 27 cm - 13,5 yaprak / m²
Bordür: 1,5 cm x 27 cm - 3,7 bordür / m
Mosaic Size 1,5 cm x 1,5 cm

Manolya

	Inox /satinox	Dekorlu /decor	Altın /gold	Bakır /bronz	Antrasit /anthracite	Inox Dekorlu /inox decor
Yaprak	IY6900 41,25 \$	IY6911 49,38 \$	IY6922 73,63 \$	IY6933 73,63 \$	IY6944 73,63 \$	IY6901 49,38 \$
Bordür	IB6900 2,50 \$	IB6911 3,00 \$	IB6922 4,63 \$	IB6933 4,63 \$	IB6944 4,63 \$	IB6901 3,00 \$

Sinada ve Manolya serisi mozaikler, 304 kalite paslanmaz çelikten üretilmektedir. Ürünün 5 farklı yüzey renk alternatifi (Inox, Dekorlu, Inox Ayna, Altın Ayna, Bakır Ayna) mevcuttur. Renkli olan ürünler paslanmaz yüzeye pvd kaplama teknolojisi ile üretilmiştir.

Mosaic produced 304 quality stainless with 31 series and 10 different surface options, thickness is 7,5 mm. It using as a decorative wall covering. Gives decorative and a stylish look to your bathroom with the use in ceramics.

INOXYLINE 3D



PAPATYA

Yaprak: 25 cm x 26,6 cm - 15,1 yaprak / m²
1. Bordür: 4,8 cm x 26,6 cm - 3,8 bordür / m
2. Bordür: 8,2 cm x 26,6 cm - 3,8 bordür / m
Mosaic Size 1,5 cm x 1,5 cm - 4,8 cm x 4,8 cm

Papatya

	Inox /satinox	Dekorlu /decor	Altın /gold	Bakır /bronz	Antrasit /anthracite	Inox Dekorlu /inox decor	Dekorlu Inox /decor inox
Yaprak	IY6300 28,38 \$	IY6311 34,13 \$	IY6322 50,75 \$	IY6333 50,75 \$	IY6344 50,75 \$	IY6301 34,13 \$	IY6310 34,13 \$
1.Bordür	IB6300 4,38 \$	IB6311 5,25 \$	IB6322 7,75 \$	IB6333 7,75 \$	IB6344 7,75 \$	IB6301 5,25 \$	IB6310 5,25 \$
2.Bordür	IB6400 9,50 \$	IB6411 11,38 \$	IB6422 17,00 \$	IB6433 17,00 \$	IB6444 17,00 \$	IB6401 11,38 \$	IB6410 11,38 \$



VIOLET

Yaprak: 29,8 cm x 30,4 cm - 11,2 yaprak / m²
Bordür: 29,8 cm x 10 cm - 3,4 bordür / m
Mosaic Size 4,8 cm x 10 cm

Violet

	Inox /satinox	Dekorlu /decor	Altın /gold	Bakır /bronz	Antrasit /anthracite	Inox Dekorlu /inox decor
Yaprak	IY2400 22,50 \$	IY2411 26,88 \$	IY2422 40,50 \$	IY2433 40,50 \$	IY2444 40,50 \$	IY2401 26,88 \$
Bordür	IB2400 7,50 \$	IB2411 9,00 \$	IB2422 13,50 \$	IB2433 13,50 \$	IB2444 13,50 \$	IB2401 9,00 \$

Papatya ve Violet serisi mozaikler, 304 kalite paslanmaz çelikten üretilmektedir. Ürünün 5 farklı yüzey renk alternatifi (Inox, Dekorlu, Inox Ayna, Altın Ayna, Bakır Ayna) mevcuttur. Renkli olan ürünler paslanmaz yüzeye pvd kaplama teknolojisi ile üretilmiştir.

Mosaic produced 304 quality stainless with 31 series and 10 different surface options, thickness is 7,5 mm. It using as a decorative wall covering. Gives decorative and a stylish look to your bathroom with the use in ceramics.



FULYA

Yaprak: 26,6 cm x 30,4 cm - 12,4 yaprak / m²
1. Bordür: 6,5 cm x 30,4 cm - 3,4 bordür / m
2. Bordür: 8,2 cm x 30,4 cm - 3,4 bordür / m
Mosaic Size 1,5 cm x 10 cm - 4,8 cm x 10 cm

Fulya

	Inox /satinox	Dekorlu /decor	Altın /gold	Bakır /bronz	Antrasit /anthracite	Inox Dekorlu /inox decor	Dekorlu Inox /decor inox
Yaprak	IY8100 22,50 \$	IY8111 27,00 \$	IY8122 41,88 \$	IY8133 41,88 \$	IY8144 41,88 \$	IY8101 27,00\$	IY8110 27,00 \$
1.Bordür	IB8100 5,63 \$	IB8111 6,75 \$	IB8122 10,44 \$	IB8133 10,44 \$	IB8144 10,44 \$	IB8101 6,75 \$	IB8110 6,75 \$
2.Bordür	IB8200 7,63 \$	IB8211 9,19 \$	IB8222 14,13 \$	IB8233 14,13 \$	IB8244 14,13 \$	IB8201 9,19 \$	IB8210 9,19 \$



İRİS

Yaprak: 27 cm x 30,4 cm - 12,2 yaprak / m²
Bordür: 1,5 cm x 30,4 cm - 3,4 bordür / m
Mosaic Size 1,5 cm x 10 cm

İris

	Inox /satinox	Dekorlu /decor	Altın /gold	Bakır /bronz	Antrasit /anthracite	Inox Dekorlu /inox decor
Yaprak	IY7500 32,5 \$	IY7511 39,00 \$	IY7522 58,88 \$	IY7533 58,88 \$	IY7544 58,88 \$	IY7501 39,00 \$
Bordür	IB7500 2,04 \$	IB7511 2,44 \$	IB7522 3,69 \$	IB7533 3,69 \$	IB7544 3,69 \$	IB7501 2,44 \$

Fulya ve İris serisi mozaikler, 304 kalite paslanmaz çelikten üretilmektedir. Ürünün 5 farklı yüzey renk alternatifi (Inox, Dekorlu, Inox Ayna, Altın Ayna, Bakır Ayna) mevcuttur. Renkli olan ürünler paslanmaz yüzeye pvd kaplama teknolojisi ile üretilmiştir.

Mosaic produced 304 quality stainless with 31 series and 10 different surface options, thickness is 7,5 mm. It using as a decorative wall covering. Gives decorative and a stylish look to your bathroom with the use in ceramics.

INOXYLINE 3D



AÇELYA

Yaprak: 26,6 cm x 26,6 cm - 14,2 yaprak / m²
Bordür: 6,5 cm x 26,6 cm - 3,8 bordür / m
Mosaic Size 1,5 cm x 1,5 cm - 4,8 cm x 4,8 cm

Açelya

	Inox /satinox	Dekorlu /decor	Altın /gold	Bakır /bronz	Antrasit /anthracite	Inox Dekorlu /inox decor	Dekorlu Inox /decor inox
Yaprak	IY6600 27,50 \$	IY6611 33,00 \$	IY6622 49,25 \$	IY6633 49,25 \$	IY6644 49,25 \$	IY6601 33,00 \$	IY6601 33,00 \$
Bordür	IB6600 6,88 \$	IB6611 8,25 \$	IB6622 12,31 \$	IB6633 12,31 \$	IB6644 12,31 \$	IB6601 8,25 \$	IB6601 8,25 \$



LEYLAK

Yaprak: 27 cm x 30,4 cm - 12,2yaprak / m²
Bordür: 1,5 cm x 30,4 cm - 3,4 bordür / m
Mosaic Size 1,5 cm x 10 cm

Leylak

	Inox /satinox	Dekorlu /decor	Altın /gold	Bakır /bronz	Antrasit /satinox	Inox Dekorlu /inox decor
Yaprak	IY9000 32,50 \$	IY9011 39,00 \$	IY9022 58,88 \$	IY9033 58,88 \$	IY9044 58,88 \$	IY9001 39,00 \$
Bordür	IB9000 2,04 \$	IB9011 2,44 \$	IB9022 3,69 \$	IB9033 3,69 \$	IB9044 3,69 \$	IB9001 2,44 \$

Açelya ve Leylak serisi mozaikler, 304 kalite paslanmaz çelikten üretilmektedir. Ürünün 5 farklı yüzey renk alternatifi (Inox, Dekorlu, Inox Ayna, Altın Ayna, Bakır Ayna) mevcuttur. Renkli olan ürünler paslanmaz yüzeye pvd kaplama teknolojisi ile üretilmiştir.

Mosaic produced 304 quality stainless with 31 series and 10 different surface options, thickness is 7,5 mm. It using as a decorative wall covering. Gives decorative and a stylish look to your bathroom with the use in ceramics.



Kardelen

KARDELEN

Yaprak: 29,8 cm x 30,4 cm - 11 yaprak / m²
 1. Bordür: 4,8 cm x 30,4 cm - 3,4 bordür / m
 2. Bordür: 4,8 cm x 30,4 cm - 3,4 bordür / m
 Mosaic Size 1,5 cm x 10 cm - 4,8 cm x 10 cm

	Inox /satinox	Dekorlu /decor	Altın /gold	Bakır /bronz	Antrasit /anthracite	Inox Dekorlu /inox decor	Dekorlu Inox /decor inox
Yaprak	IY7800 29,38 \$	IY7811 35,25 \$	IY7822 53,28 \$	IY7833 53,38 \$	IY7844 53,38 \$	IY7801 35,25 \$	IY7810 35,25 \$
1.Bordür	IB7800 4,40 \$	IB7811 5,28 \$	IB7822 8,19 \$	IB7833 8,19 \$	IB7844 8,19 \$	IB7801 5,28 \$	IB7810 5,28 \$
2.Bordür	IB7900 5,28 \$	IB7911 6,25 \$	IB7922 9,63 \$	IB7933 9,63 \$	IB7944 9,63 \$	IB7901 6,25 \$	IB7910 6,25 \$



Defne

DEFNE

Yaprak: 27,4 cm x 27,4 cm - 13,2 yaprak / m²
 Bordür: 2,1 cm x 27,4 cm - 3,7 bordür / m
 Mosaic Size 2,5 cm x 2,5 cm

	Inox /satinox	Dekorlu /decor	Altın /gold	Bakır /bronz	Antrasit /anthracite	Inox Dekorlu /inox decor
Yaprak	IY9300 29,00 \$	IY9311 34,80 \$	IY9322 52,25 \$	IY9333 52,25 \$	IY9344 52,25 \$	IY9301 31,90 \$
Bordür	IB9300 2,90 \$	IB9311 3,48 \$	IB9322 5,23 \$	IB9333 5,23 \$	IB9344 5,23 \$	IB9301 3,19 \$

Kardelen ve Defne serisi mozaikler, 304 kalite paslanmaz çelikten üretilmektedir. Ürünün 5 farklı yüzey renk alternatifi (Inox, Dekorlu, Inox Ayna, Altın Ayna, Bakır Ayna) mevcuttur. Renkli olan ürünler paslanmaz yüzeye pvd kaplama teknolojisi ile üretilmiştir.

Mosaic produced 304 quality stainless with 31 series and 10 different surface options, thickness is 7,5 mm. It using as a decorative wall covering. Gives decorative and a stylish look to your bathroom with the use in ceramics.



VADI ISTANBUL LEDAP



SEA PEARL



YEDI MAYI



TEMA ISTANBUL



DAP VADO KULE



S. LEVINT



PRUVA 34



STRADA BAKESHIH



PIAZZA KONESIH MALTEPE



SKYLAND



VADI ISTANBUL X. ICM



KUZU KUMBRI ANKARA



BAHI MAHAL VILLALARI



ARTAS ATAKENT 4



ARTZMA KONUTLARI



KIVIPARK



BAHCESEHIR KONAKLARI



SIDAPARK KAYASEHIR



EVIM KADIKOY



EMAY KENT PLUS



ARTAS KSAROY



KALE DAIRE KARTAL



101 KADIKOY



GARANTI KOCA



ISIT CONCEPT



BAYRAMPASA KENTSEL DONUSUM



KARAT 34



YAGITEPE ODELELERI



GÖL PınAROMA



KALE TOPRAKI



TOYA MEDIA



ECLIPSE MASLA



OYAPARK



DAP HÜRÜÜ KULE



CAPİTOL AVM



TAKSİM PİTEK RESİDENCE



CAROUSEL AVM



HARVEY NICHOLS



TUI BLUE OTEL ANTALYA



SAHİL KONAKLARI



ORAY LIFE RESİDENCE



LUXRA RESİDENCE



LAFONYA CITY



ALOTYA MOONPARK



EGİT WORLD OTEL



ABU DHABI RİXOS OTEL



TRABZON MARİNCİTY



EMUKENT BURSA



DOAL İSTANBUL



ARWIN MERLIN



BAKİRKÖY CITY1



BAKİRKÖY CITY2



CORDELLA KAVAL



DGA MARE



EVİM YÜKSEKDAĞ



KARTAL 301



OPTON KOÇUYOLU



OPTON YALIKAVAK



OPTON SİLLİ



OPTON BEYKOZ



OPTON KANDILLI



DAP Z OTU



DAP TANDO KULE



KIZILIRMAK HAVALIMANI



SERTİFİKALAR

PH Dizayn



ÇEVRE YÖNETİM SİSTEMİ SERTİFİKASI

Universal GmbH

Bu sertifika,

**PH DİZAYN YAPI ÜRÜNLERİ SAN.
VE TİC. LTD. ŞTİ.**

Ferhatpaşa Mah. 19. Sok. No:5-11 Ataşehir/İSTANBUL/TÜRKİYE

kuruluşunun,

**AÇIK PROFİLLERİN, NERVÜRLÜ LEVHALARIN VE SANDVIÇ
PANELLERİN SOĞUK ŞEKİLLENDİRME VEYA KATLAMA
YÖNTEMİYLE İMALATI**

Kapsamında, IA2-2-5967 sayılı rapordaki inceleme ile

DIN EN ISO 14001:2015

standardının şartlarına uyan bir yönetim sistemi
kurduğunu ve uyguladığını onaylamak üzere verilmiştir.

Sertifika No : EMS 1020 003058

İlk Yayın Tarihi : 26.10.2020

Yayın / Revizyon Tarihi : 26.10.2020

Geçerlilik Tarihi : 25.10.2021

Belge Periyodu : 3 yıl (1. yıl)



Deutsche
Akkreditierungsstelle
D-2M-16058-01-00

Universal GmbH

Ambsuer

The authenticity of this certificate can be confirmed online or by e-mail to the Head Office via:

UNIVERSAL GmbH • Wilfried Diekmann Str., 20b, 44536 Lünen Germany • T: +49 (0) 231 9931 9960 • info@uni-cert.de • www.uni-cert.de

ZERTIFIKAT • CERTIFICATE • CERTIFICADO • CERTIFICAT



SERTİFİKALAR

PH Dizayn

ZERTIFIKAT • CERTIFICATE • CERTIFICADO • CERTIFICAT

ZERTIFIKAT • CERTIFICATE • CERTIFICADO • CERTIFICAT



İŞ SAĞLIĞI VE GÜVENLİĞİ YÖNETİM SİSTEMİ SERTİFİKASI

Universal GmbH

Bu sertifika,

**PH DİZAYN YAPI ÜRÜNLERİ SAN.
VE TİC. LTD. ŞTİ.**

Ferhatpaşa Mah. 19. Sok. No:5-11 Ataşehir/İSTANBUL/TÜRKİYE

kuruluşunun,

**AÇIK PROFİLLERİN, NERVÜRLÜ LEVHALARIN VE SANDVIÇ
PANELLERİN SOĞUK ŞEKİLLENDİRME VEYA KATLAMA
YÖNEMİYLE İMALATI**

Kapsamında, İA2-2-5987 sayılı rapordaki inceleme ile

ISO 45001:2018

standartının şartlarına uyum bir yönetim sistemi
kuruluşunu ve uyguladığını onaylamak üzere verilmiştir.

Sertifika No : İSGMS 1020 003039

İlk Yayın Tarihi : 26.10.2020

Yayın / Revizyon Tarihi : 26.10.2020

Geçerlilik Tarihi : 25.10.2021

Belge Periyodu : 3 yıl (1. yıl)



Ambarcan

Universal GmbH

The authenticity of this certificate can be confirmed online or by e-mail to the Head Office via

100070046, Berlin • Yildiz Sokakı No: 25, 41031 Üsküdar Germany • T: +49 30 201 6001 9980 • info@unicert.de • www.unicert.de



KALİTE YÖNETİM SİSTEMİ SERTİFİKASI

Universal GmbH

Bu sertifika,

**PH DİZAYN YAPI ÜRÜNLERİ SAN.
VE TİC. LTD. ŞTİ.**

Ferhatpaşa Mah. 19. Sok. No:5-11 Ataşehir/İSTANBUL/TÜRKİYE

kuruluşunun,

**AÇIK PROFİLLERİN, NERVÜRLÜ LEVHALARIN VE SANDVIÇ
PANELLERİN SOĞUK ŞEKİLLENDİRME VEYA KATLAMA
YÖNEMİYLE İMALATI**

Kapsamında, İA2-2-5987 sayılı rapordaki inceleme ile

DIN EN ISO 9001:2015

standartının şartlarına uyum bir yönetim sistemi
kuruluşunu ve uyguladığını onaylamak üzere verilmiştir.

Sertifika No : QMS 1020 003037

İlk Yayın Tarihi : 26.10.2020

Yayın / Revizyon Tarihi : 26.10.2020

Geçerlilik Tarihi : 25.10.2021

Belge Periyodu : 3 yıl (1. yıl)



DAkkS

Deutsche
Akreditationsstelle
D-30559 Hannover

Ambarcan

The authenticity of this certificate can be confirmed online or by e-mail to the Head Office via

100070046, Berlin • Yildiz Sokakı No: 25, 41031 Üsküdar Germany • T: +49 30 201 6001 9980 • info@unicert.de • www.unicert.de



PH Dizayn Yapı Ürünleri San. ve Tic. Ltd. Şti.

Ferhatpaşa Mahallesi 19.Sokak No:5-11 Ataşehir/ İSTANBUL / TÜRKİYE

T : +90 216 388 78 80 / +90 216 388 77 90

F : +90 216 388 78 14

www.phdizayn.com / info@phdizayn.com

2021